

CAMSHELVING®

THE COMMON AND KEY FEATURES OF ALL CAMSHELVING SERIES

Rust and Corrosion Free

Backed by a lifetime warranty against rust and corrosion, Camshelving storage systems eliminate the inconvenience and costs associated with restoring or replacing degraded shelving. Only Cambro offers Shelving for Life.



Multi Environment Use

Camshelving storage systems are designed to withstand all extreme storage applications and temperatures — impervious to moisture, chemicals, salt, food acids, and humidity. Camshelving systems can be installed anywhere and will never rust.

-38°C TO 88°C



Maximized Space Utilization

Components have been thoughtfully designed to maximize storage space, even in space-restricted areas.

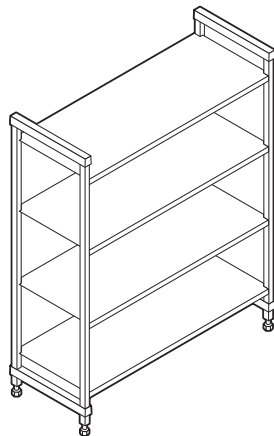

Starter Unit

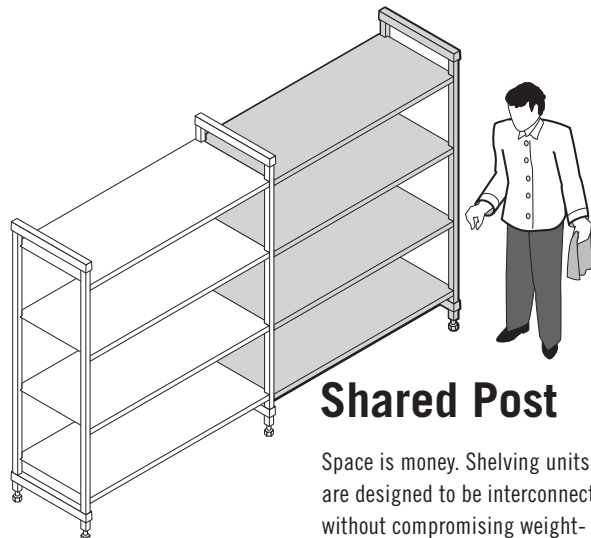

Starter + Add-On Unit

Shared Post

Space is money. Shelving units are designed to be interconnected, without compromising weight-bearing capacity all while maximizing usable storage space.

PREMIUM series

ELEMENTS series

BASICS series

Easy to Clean

Cleaning shelving shouldn't be a major production. Whether daily or scheduled, cleaning can be done quickly and easily without interrupting storage space or normal, day-to-day operations.



Easy to Adjust

Each shelf can be easily and independently adjusted to accommodate a variety of storage products and packages as product and storage needs change.

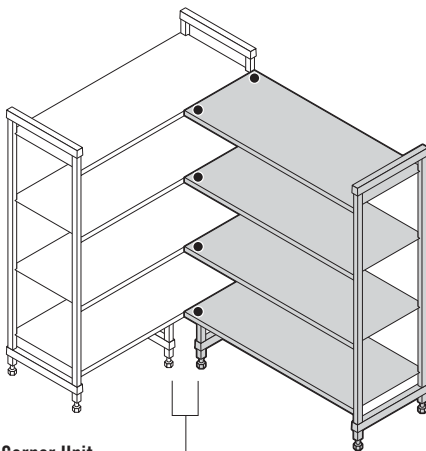

Corner Unit
Starter + Add-On Unit
using 1 set of Corner
Connectors per shelf
and 2 Dunnage Stands.

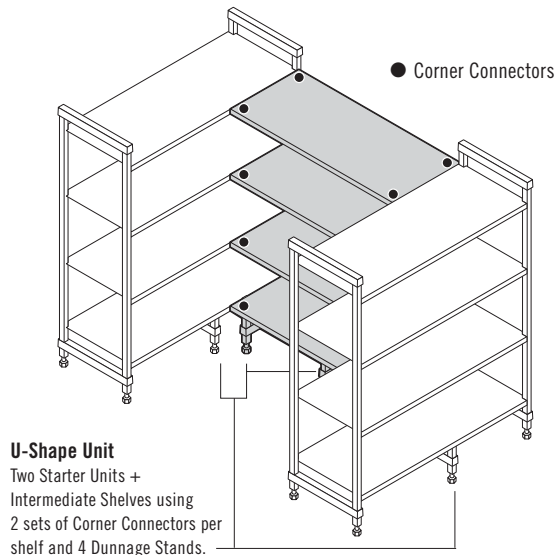

U-Shape Unit
Two Starter Units +
Intermediate Shelves using
2 sets of Corner Connectors per
shelf and 4 Dunnage Stands.

Corner Shelf Space

Convert unusable space into continuous, easy-access storage areas using corner connectors.

Camshelving® Series Quick Reference Guide

Cambro offers three rust-free, non-corrosive, hygienic shelving systems that will hold up to the tough demands of commercial foodservice operations. This guide will help you choose the ideal Camshelving system for each storage area in your operation. Only Cambro offers Shelving for Life.



camguard
ANTIMICROBIAL SHELF PLATES

PREMIUM series

Storage Areas	High-volume foodservice operations with constant loading and off-loading of heavy products. Frequent and/or multiple daily deliveries. Wet Storage - Walk-in Freezers, Coolers, Warewashing Areas Dry Storage - Bulk Foods, Catering Equipment, China/Dishware, Linen, Merchandising.
Recommended Market Segments	Hotels and Casinos, Restaurants, Quick-Serve Restaurants, Schools, Colleges and Universities, Healthcare, Military, Convention Centers/Stadiums, Cruise Ships, Caterers and Banquet Centers, Corporate Dining, Convenience and Grocery Stores.
Product Material	Posts and traverses are made from a steel core with smooth polypropylene exterior. Superior strength and durable enough to withstand the heaviest loading demands.
Assembly	Molded in dovetails means fewer parts, making it the easiest to assemble.
Weight-Bearing Capacity (based on 610 - 1220 mm length)	Stationary Unit: 363 kg per shelf, 1451 kg per unit. Mobile Unit: 340 kg per unit. Corner and U-Shape Unit: 181 kg per shelf, 726 kg per unit.
Lifetime Warranty Against Rust & Corrosion	Shelf Plates, Posts and Traverses
Shelf Lengths	610, 760, 910, 1070, 1220, 1380, 1530, 1830 mm
Shelf Depths	360, 460, 540, 610 mm
Post Heights	Stationary: 820, 1430, 1630, 1830, 2140 mm Mobile: 890, 1500, 1700, 1910 mm (includes casters)
Mobile Units	YES
High Density Storage Floor Track System	YES
Bottom Shelf Dunnage Stand	YES
Shelf Rails	YES
Vertical Drying and Storage Cradle (Trays / Cutting Boards / Lids)	YES
Dome Drying and Storage Cradle	YES
Angled Drying and Storage Cradle	YES
Shelf Divider (Narrow Item Storage)	YES
Shelf Divider Bar (for Food Pans or Food Boxes)	YES
Tray Sliding Rack	YES
Single Shelf Security Cage	YES
Full Wrap Security Cage	YES

ACCESSORIES



ELEMENTS series

BASICS series

<p>High-volume foodservice operations with constant loading and off-loading of medium to heavy products. 5-7 deliveries per week.</p> <p>Wet Storage - Walk-in Freezers, Coolers, Warewashing Areas</p> <p>Dry Storage - Bulk Foods, Catering Equipment, China/Dishware, Linen, Merchandising.</p>	<p>Medium-volume foodservice operations with constant loading and off-loading of light to medium products. 2-5 deliveries per week.</p> <p>Wet Storage - Walk-in Freezers, Coolers, Warewashing Areas</p> <p>Dry Storage - Bulk Foods, Catering Equipment, China/Dishware, Linen, Merchandising.</p>
<p>Hotels and Casinos, Restaurants, Quick-Serve Restaurants, Schools, Colleges and Universities, Healthcare, Military, Convention Centers/Stadiums, Cruise Ships, Caterers and Banquet Centers, Corporate Dining, Convenience and Grocery Stores.</p>	<p>Hotels and Casinos, Restaurants, Quick-Serve Restaurants, Schools, Colleges and Universities, Healthcare, Convention Centers/Stadiums, Caterers and Banquet Centers, Corporate Dining, Convenience Stores, Yogurt Shops and Cafés.</p>
<p>Posts and traverses are made from a revolutionary composite material that is light in weight yet strong enough to withstand rigorous loading conditions.</p>	<p>Posts and traverses are made from the same revolutionary composite material as Elements Series. Slim design is lighter in weight, yet durable and strong enough to withstand a wide variety of storage conditions.</p>
<p>Easy to assemble.</p>	<p>Easy to assemble.</p>
<p>Stationary Unit: 363 kg per shelf, 1451 kg per unit. Mobile Unit: 340 kg per unit. Corner and U-Shape Unit: 181 kg per shelf, 726 kg per unit.</p>	<p>Stationary Unit: 272 kg per shelf, 998 kg per unit. Corner and U-Shape Unit: 136 kg per shelf, 544 kg per unit.</p>
<p>Shelf Plates, Posts and Traverses</p>	<p>Shelf Plates, Posts and Traverses</p>
<p>610, 760, 910, 1070, 1220, 1380, 1530, 1830 mm</p>	<p>760, 910, 1070, 1220, 1380, 1530 mm</p>
<p>360, 460, 540, 610 mm</p>	<p>460, 540, 610 mm</p>
<p>Stationary: 1630, 1830, 2140 mm Mobile: 1778, 1980 mm (includes casters)</p>	<p>Stationary: 1630, 1830, 2140 mm</p>
YES	NO
NO	NO
YES	YES
NO	NO
YES	YES
YES	YES
YES	YES
YES	YES
YES	NO
YES	YES
YES	YES
NO	NO

Product Code Reference Guide

Cambro's new product codes have been simplified making it easier to identify the type of unit or accessory required. Code numbers are composed of 3 parts.

1. **Prefix** – Defines the shelving brand and type and of unit being selected.
2. **Dimensions** – Identifies the depth, length and height.
3. **Suffix** – Type and quantity of shelves.

Complete Units

CP Camshelving® Premium Series

- CPU Stationary Starter Unit
- CPA Stationary Add-On Unit
- CPMU Mobile Unit
- CPHU High Density Mobile Unit

E Camshelving Elements Series

- ESU Stationary Starter Unit
- EA Stationary Add-On Unit
- EMU Mobile Unit

CB Camshelving Basics Series

- CBU Stationary Starter Unit
- CBA Stationary Add-On Unit

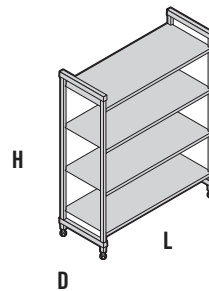
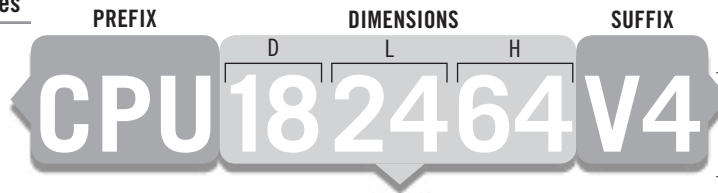

V4 4 Vented Shelves

V5 5 Vented Shelves

S4 4 Solid Shelves

S5 5 Solid Shelves

VS4 3 Vented Shelves + 1 Solid Shelf

VS5 4 Vented Shelves + 1 Solid Shelf

V4PKG* 4 Vented Shelves

V5PKG* 5 Vented Shelves

VS4PKG* 3 Vented Shelves + 1 Solid Shelf

VS5PKG* 4 Vented Shelves + 1 Solid Shelf

* Premium Series only - 2140 mm high units.

Post Kits and Shelf Kits

CP Camshelving® Premium Series

- CPSK Stationary Shelf Kit
- CPPK Stationary Post Kit
- CPMPK Mobile Post Kit

E Camshelving Elements Series

- ESK Stationary Shelf Kit
- EPK Stationary Post Kit
- EMSK Mobile Shelf Kit
- EMPK Mobile Post Kit

CB Camshelving Basics Series

- CBSK Stationary Shelf Kit
- CBPK Stationary Post Kit

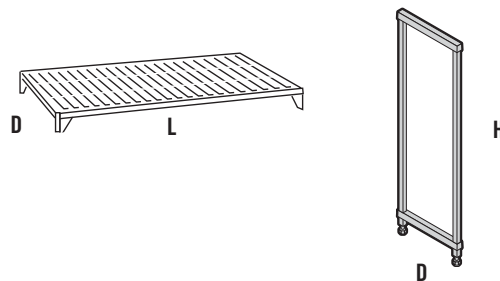
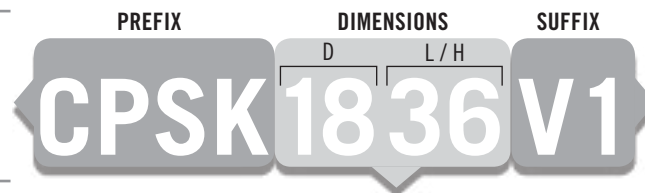

V1 1 Vented Shelf

S1 1 Solid Shelf

V4 4 Vented Shelves

V5 5 Vented Shelves

S4 4 Solid Shelves

S5 5 Solid Shelves

VS4 3 Vented Shelves + 1 Solid Shelf

VS5 4 Vented Shelves + 1 Solid Shelf

Accessories

If an accessory is used by more than 1 line of shelving, the code will start with CS.

If an accessory is only used in one line of shelving, the code will start by the prefix letters of the line.

Example: Corner Connectors:

- a. **CPC1** = Camshelving Premium Corner Connector Set
- b. **ECC1** = Camshelving Elements Corner Connector Set
- c. **CBCC1** = Camshelving Basics Corner Connector Set

FREE Camshelving® Design Service

In order to select the most suitable and cost effective storage system, Cambro offers a custom shelving design service using a proprietary shelving design program. Space allocation, operational flow and organizational challenges are quickly addressed with the right product. Usable storage space is maximized with the least number of units. Once all required information is received, our expert shelving consultants prepare a 2D and 3D recommended floor plan with an itemized product list by room/area. Proposals are completed and emailed within 24 - 48 business day hours, depending on number of rooms and complexity.

We look forward to designing the perfect storage solution for you. Call or email today to connect with one of our Camshelving consultants.

Email shelving@Cambro.com or call CAMBRO USA: 1(714)230-4113

It's Simple! To Get Started, Please Provide:

- Project Name
- Storage Room Type (freezer / cooler)
- Room(s) Dimensions (L x W x H)
- Doorway / Entryway Location & Dimension
- Obstructions (condenser / pipes)
- Additional Preferences / Requirements

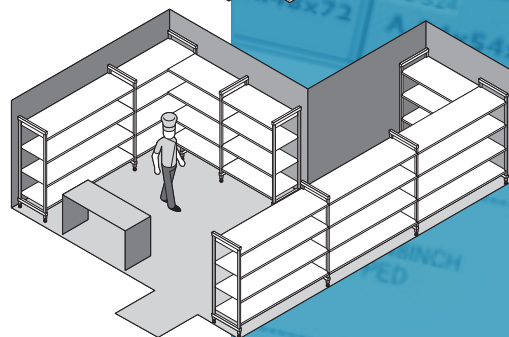
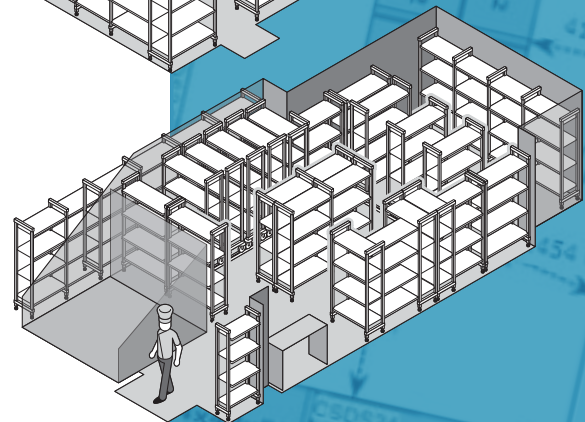
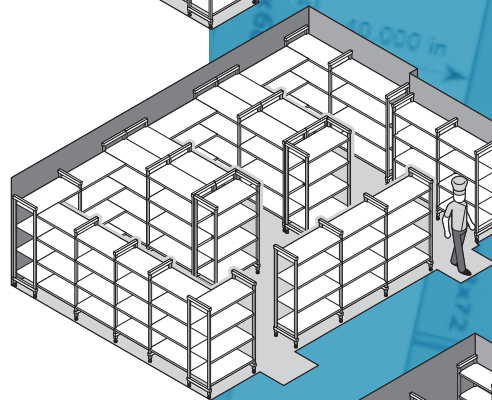
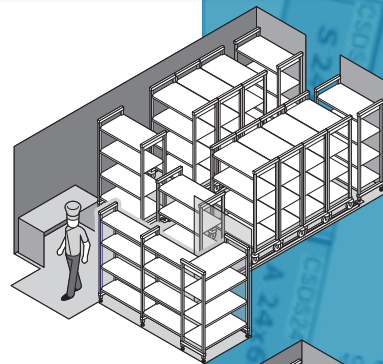
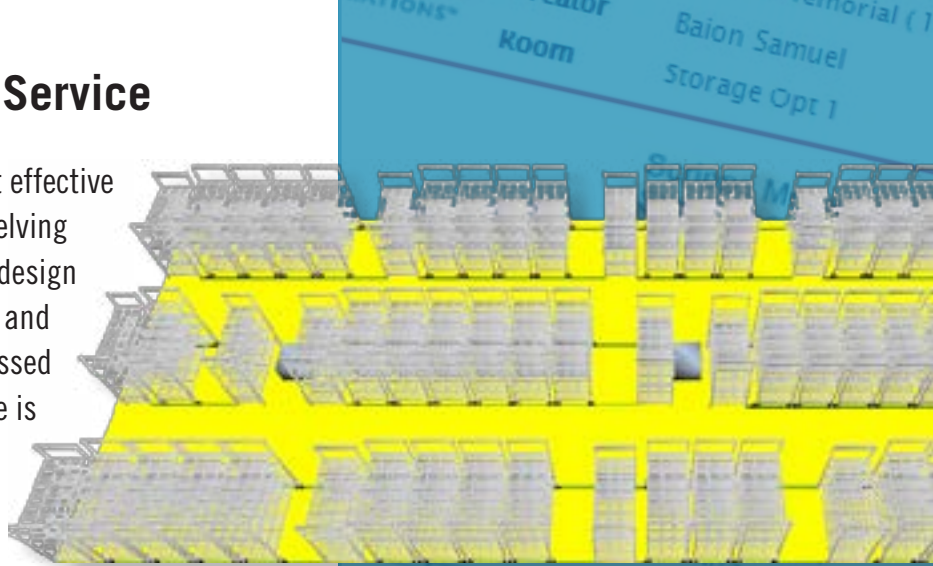

Camshelving® Series Overall Length - Quick Reference Guide

Straight Unit: Starter Unit + Add-On Unit with Shared Posts

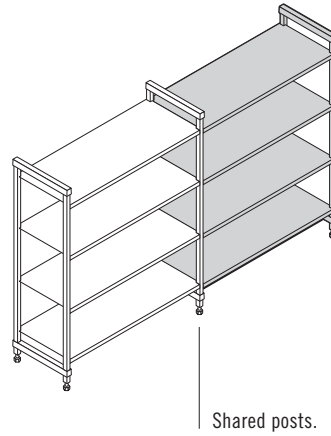
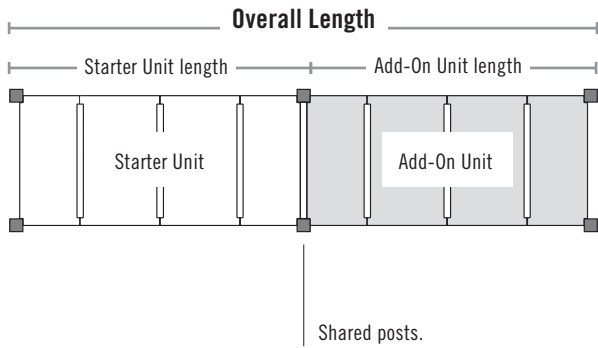

Corner Unit: Starter Unit + Add-On Unit with Corner Connectors

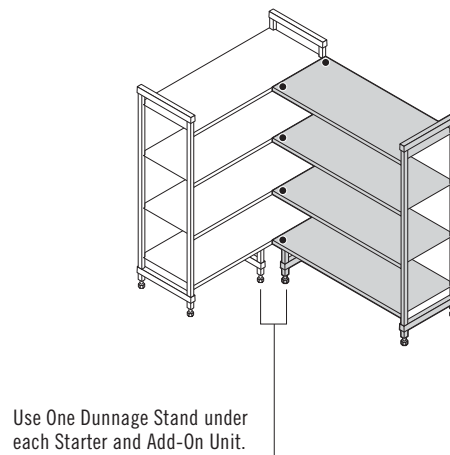
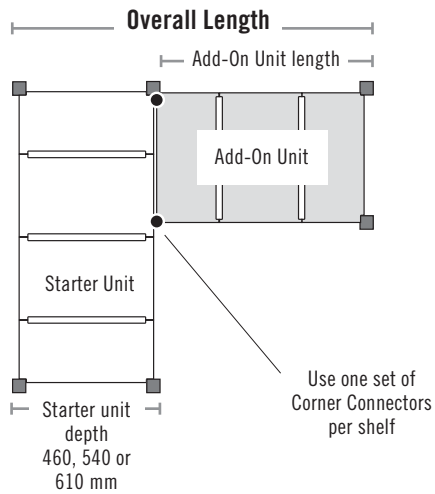

U-Shape Unit: Two Starter Units + Intermediate Shelves with Corner Connectors

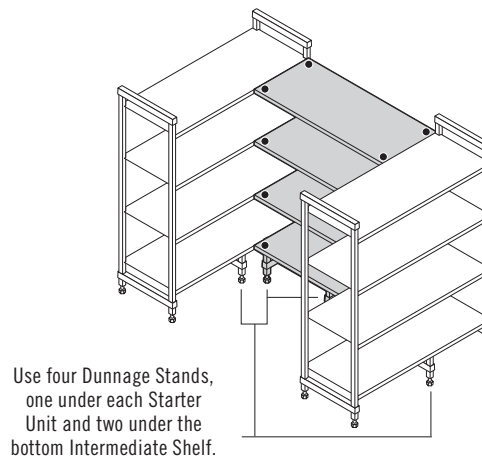
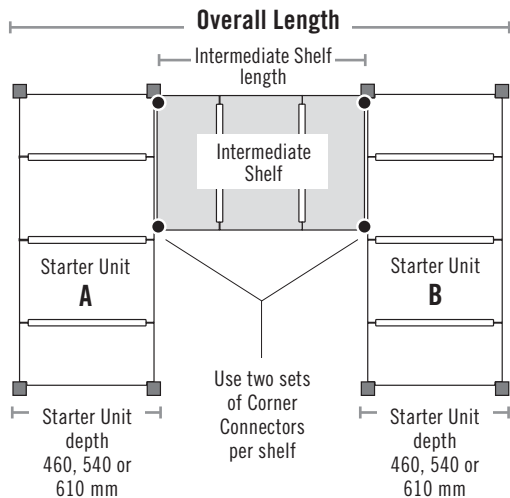

Straight Unit: Starter Unit + Add-On Unit with Shared Posts

PREMIUM / BASICS SERIES					ELEMENTS SERIES				
STARTER & ADD-ON UNIT	STARTER UNIT ACTUAL LENGTH		ADD-ON UNIT ACTUAL LENGTH	OVERALL LENGTH	STARTER UNIT ACTUAL LENGTH		ADD-ON UNIT ACTUAL LENGTH	OVERALL LENGTH	
610	610	+	565	= 1175	610	+	559	= 1169	
760	760	+	720	= 1480	760	+	714	= 1474	
910	910	+	870	= 1780	910	+	864	= 1774	
1070	1070	+	1025	= 2095	1070	+	1019	= 2089	
1220	1220	+	1175	= 2395	1220	+	1169	= 2389	
1380	1380	+	1330	= 2710	1380	+	1324	= 2704	
1530	1530	+	1480	= 3010	1530	+	1474	= 3004	
1830	1830	+	1790	= 3620	1830	+	1784	= 3614	

610 and 1830 are not available in Camshelving Basics Series.

Corner Unit: Starter Unit + Add-On Unit with Corner Connectors

PREMIUM / ELEMENTS / BASICS SERIES					PREMIUM / ELEMENTS / BASICS SERIES					PREMIUM / ELEMENTS / BASICS SERIES				
ADD-ON UNIT	ADD-ON UNIT ACTUAL LENGTH		460 MM STARTER UNIT DEPTH	OVERALL LENGTH	ADD-ON UNIT ACTUAL LENGTH		540 MM STARTER UNIT DEPTH	OVERALL LENGTH	ADD-ON UNIT ACTUAL LENGTH		610 MM STARTER UNIT DEPTH	OVERALL LENGTH		
610	585	+	460	= 1045	585	+	540	= 1125	585	+	610	= 1195		
760	740	+	460	= 1200	740	+	540	= 1280	740	+	610	= 1350		
910	890	+	460	= 1350	890	+	540	= 1430	890	+	610	= 1500		
1070	1045	+	460	= 1505	1045	+	540	= 1585	1045	+	610	= 1655		
1220	1195	+	460	= 1655	1195	+	540	= 1735	1195	+	610	= 1805		

610 mm unit not available in Camshelving Basics Series.

U-Shape Unit: Two Starter Units + Intermediate Shelves with Corner Connectors

PREMIUM / ELEMENTS / BASICS SERIES					PREMIUM / ELEMENTS / BASICS SERIES					PREMIUM / ELEMENTS / BASICS SERIES				
INTERMEDIATE SHELF	INTERMEDIATE SHELF ACTUAL LENGTH		460 MM DEPTH STARTER UNIT A+B	OVERALL LENGTH	INTERMEDIATE SHELF ACTUAL LENGTH		540 MM DEPTH STARTER UNIT A+B	OVERALL LENGTH	INTERMEDIATE SHELF ACTUAL LENGTH		610 MM DEPTH STARTER UNIT A+B	OVERALL LENGTH		
910	865	+	920	= 1785	865	+	1080	= 1945	865	+	1220	= 2085		
1070	1020	+	920	= 1940	1020	+	1080	= 2100	1020	+	1220	= 2240		
1220	1170	+	920	= 2090	1170	+	1080	= 2250	1170	+	1220	= 2390		

CAMSHELVING® PREMIUM series

WHY CHOOSE PREMIUM?

In high volume foodservice operations with frequent deliveries and constant loading and off-loading of products, stability, strength and sanitary storage should never be compromised. Premium Series does precisely what it was designed to do – hold the heaviest products with the roughest handling, in any environment and it is the easiest to clean and adjust.

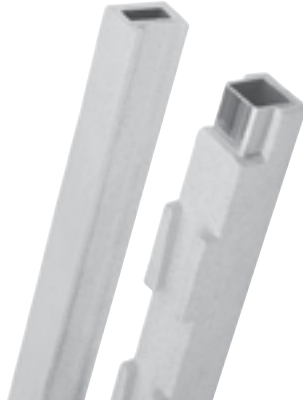

All Environments
-38°C TO 88°C

Stationary

High Density

Mobile

camguard
ANTIMICROBIAL SHELF PLATES



storage needs
HEAVY

daily deliveries
FREQUENT

Post Connectors, Corner Connectors, Seismic Foot, Wall Fastener, Identification Tags, Full Wrap Security Cage, Single Shelf Security Cage, Tray Slide Rack, Shelf Rails, Shelf Divider Bars, High Density Track and Extension Kits are not NSF Listed.

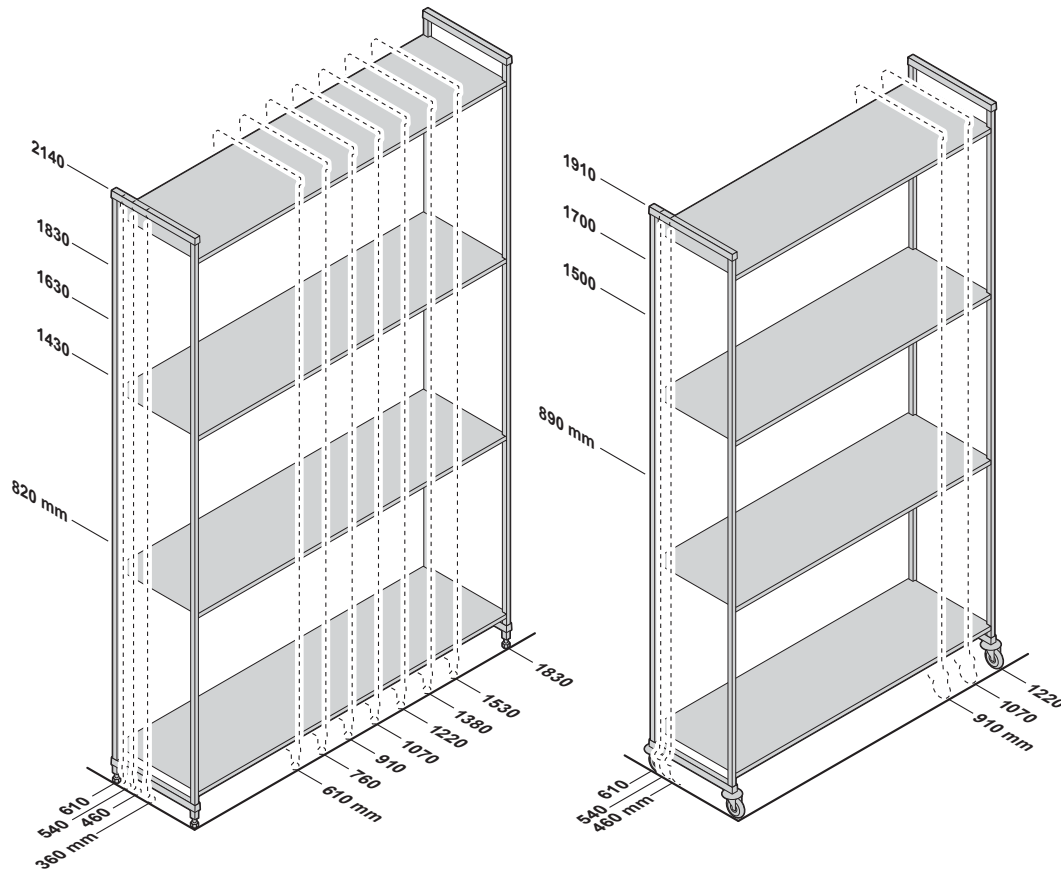

4 Shelf Unit Weight Bearing Chart

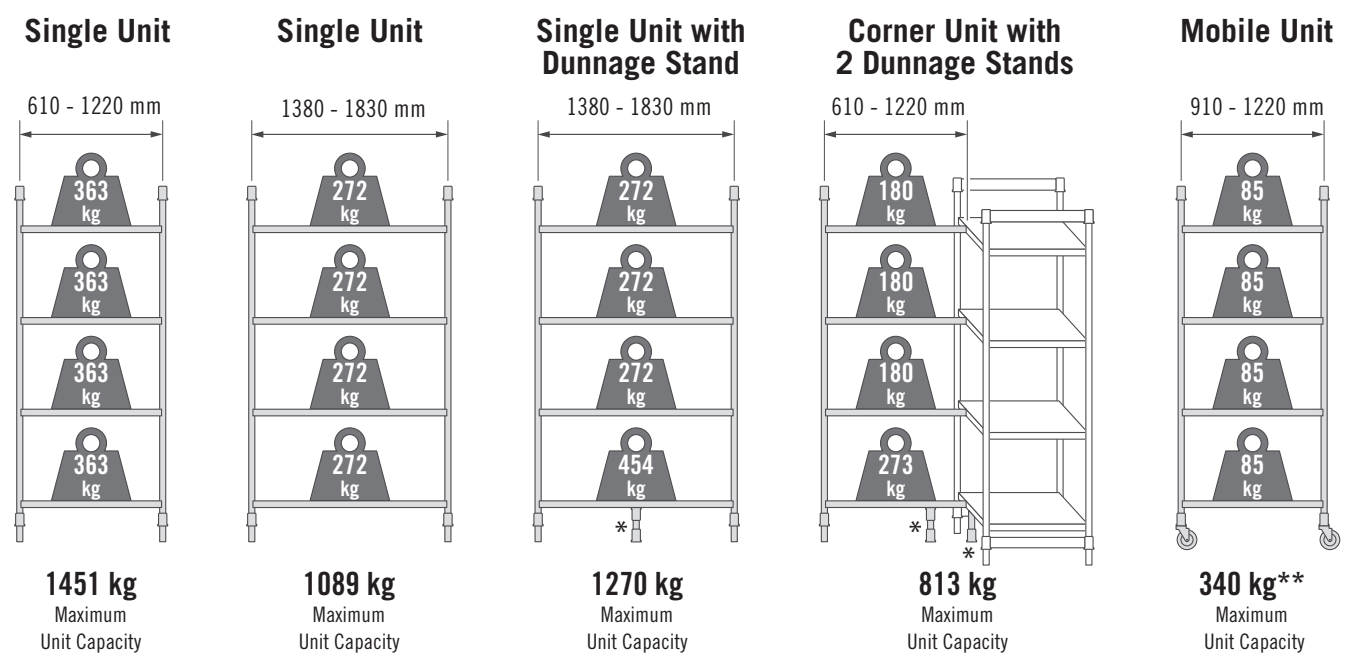

* Dunnage Stands add stability and increase weight bearing capacity on bottom shelf only. Add to any shelf length. Highly recommended for Starter Units 1380 mm and longer, all Corner Units, U-Shape Units and units specified for heavier loads (see page 92).
 ** Due to the weight bearing capacity of casters, maximum weight load on an entire Mobile Unit is 340 kg.

Camshelving® Premium Series

Starter, Add-On and Mobile Units

These units make ordering easy and saves time and labor during installation. Units ship complete in one box.* Post kits are pre-assembled at the factory, speeding up on site set up.

*Due to unit weight and size, all 2140 mm units ship in multiple boxes of post kits (unassembled) and shelf kits.





4-Shelf Vented Stationary Starter and Add-On Units

Starter units include 2 factory assembled post kits and shelves.

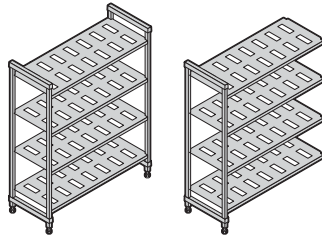
Add-On units include 1 factory assembled post kit and shelves.



1630 and 1830 mm units ship in  1

1830 mm long & 2140 mm Add-on units ship in  2

1830 mm long & 2140 mm Starter units ship in  3

HEIGHTS	DEPTHS	LENGTHS	
3	3	8	
1630 mm	460 mm	610 mm	1220 mm
1830	540	760	1380
2140	610	910	1530
		1070	1830

4-Shelf Solid Stationary Starter and Add-On Units

Starter units include 2 factory assembled post kits and shelves.

Add-On units include 1 factory assembled post kit and shelves.

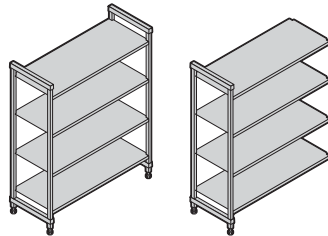

1630 and 1830 mm units ship in  1

1830 mm long & 2140 mm Add-on units ship in  2

1830 mm long & 2140 mm Starter units ship in  3

HEIGHTS	DEPTHS	LENGTHS	
3	3	8	
1630 mm	460 mm	610 mm	1220 mm
1830	540	760	1380
2140	610	910	1530
		1070	1830

4-Shelf Vented and Solid Stationary Starter and Add-On Units (3 vented + 1 solid)

Starter units include 2 factory assembled post kits and shelves.

Add-On units include 1 factory assembled post kit and shelves.

Install solid shelf on bottom to prevent water/cleaning solutions from sloshing up onto stored products. Install solid shelf on top to protect product stored on lower shelves from condensation in cooler.

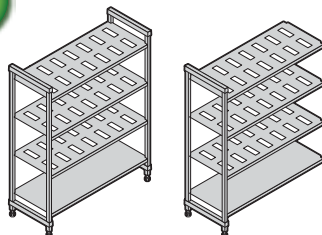

1630 and 1830 mm units ship in  1

1830 mm long & 2140 mm Add-on units ship in  2

1830 mm long & 2140 mm Starter units ship in  3

HEIGHTS	DEPTHS	LENGTHS	
3	3	8	
1630 mm	460 mm	610 mm	1220 mm
1830	540	760	1380
2140	610	910	1530
		1070	1830

5-Shelf Vented Stationary Starter and Add-On Units

Starter units include 2 factory assembled post kits and shelves.

Add-On units include 1 factory assembled post kit and shelves.

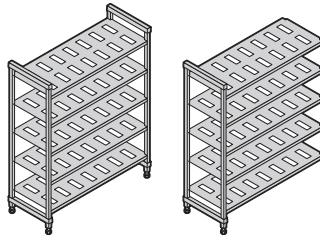

1630 and 1830 mm units ship in 

1830 mm long & 2140 mm Add-on units ship in 

1830 mm long & 2140 mm Starter units ship in 

HEIGHTS	DEPTHS	LENGTHS	
3	3	8	
1630 mm	460 mm	610 mm	1220 mm
1830	540	760	1380
2140	610	910	1530
		1070	1830

5-Shelf Solid Stationary Starter and Add-On Units

Starter units include 2 factory assembled post kits and shelves.

Add-On units include 1 factory assembled post kit and shelves.

New!

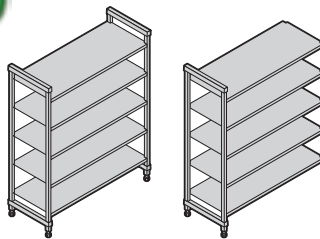

2140 mm Add-on units ship in 

2140 mm Starter units ship in 

HEIGHT	DEPTHS	LENGTHS	
1	3	8	
2140 mm	460 mm	610 mm	1220 mm
	540	760	1380
	610	910	1530
		1070	1830

5-Shelf Vented and Solid Stationary Starter And Add-On Units (4 vented + 1 solid)

Starter units include 2 factory assembled post kits and shelves.

Add-On units include 1 factory assembled post kit and shelves.

Install solid shelf on bottom to prevent water/cleaning solutions from sloshing up onto stored products. Install solid shelf on top to protect product stored on lower shelves from condensation in cooler.

New!

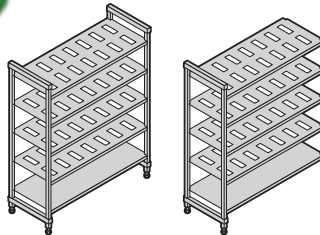

2140 mm Add-on units ship in 

2140 mm Starter units ship in 

HEIGHT	DEPTHS	LENGTHS	
1	3	8	
2140 mm	460 mm	610 mm	1220 mm
	540	760	1380
	610	910	1530
		1070	1830

4 or 5-Shelf Vented Mobile Starter Units

Mobile starter units include 2 factory assembled mobile post kits, shelves and 4 premium swivel casters with total locking brake.

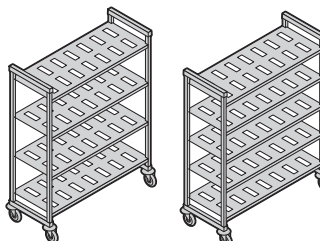

HEIGHTS*	DEPTHS	LENGTHS	
2	3	3	
1700 mm	460 mm	910 mm	
1910	540	1070	
	610	1220	

* Includes 127 mm casters.

Ships in 



Visit the Camshelving Microsite at www.cambro.com/camshelving for product information and pricing on ALL available shelving products. View or download the Camshelving Specification and Price List. Or scan QR code.

PREMIUM
SERIES

V4 4-Shelf Vented Units

1630
mm
HEIGHT

Starter units include 2 factory assembled post kits and shelves. Add-on units include 1 factory assembled post kit and shelves. Units ship complete in 1 box.

Starter

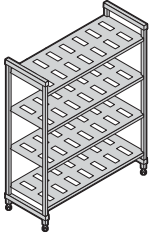

Add-On

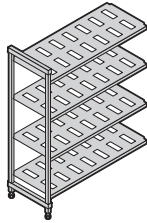

460 mm
DEPTH

DIMENSIONS D x L x H (MM)

460 x 610 x 1630
460 x 760 x 1630
460 x 910 x 1630
460 x 1070 x 1630
460 x 1220 x 1630
460 x 1380 x 1630
460 x 1530 x 1630
460 x 1830 x 1630

CODE

CPU182464V4
CPU183064V4
CPU183664V4
CPU184264V4
CPU184864V4
CPU185464V4
CPU186064V4
CPU187264V4PKG

CODE

CPA182464V4
CPA183064V4
CPA183664V4
CPA184264V4
CPA184864V4
CPA185464V4
CPA186064V4
CPA187264V4PKG

PKG units ship same as 2140 mm units.

540 mm
DEPTH

540 x 610 x 1630
540 x 760 x 1630
540 x 910 x 1630
540 x 1070 x 1630
540 x 1220 x 1630
540 x 1380 x 1630
540 x 1530 x 1630
540 x 1830 x 1630

CPU212464V4
CPU213064V4
CPU213664V4
CPU214264V4
CPU214864V4
CPU215464V4
CPU216064V4
CPU217264V4PKG

CPA212464V4
CPA213064V4
CPA213664V4
CPA214264V4
CPA214864V4
CPA215464V4
CPA216064V4
CPA217264V4PKG

PKG units ship same as 2140 mm units.

610 mm
DEPTH

610 x 610 x 1630
610 x 760 x 1630
610 x 910 x 1630
610 x 1070 x 1630
610 x 1220 x 1630
540 x 1380 x 1630
610 x 1530 x 1630
610 x 1830 x 1630

CPU242464V4
CPU243064V4
CPU243664V4
CPU244264V4
CPU244864V4
CPU245464V4
CPU246064V4
CPU247264V4PKG

CPA242464V4
CPA243064V4
CPA243664V4
CPA244264V4
CPA244864V4
CPA245464V4
CPA246064V4
CPA247264V4PKG

PKG units ship same as 2140 mm units.

Color: Speckled Grey (480).

PREMIUM
SERIES

V4 4-Shelf Vented Units

1830
mm
HEIGHT

Starter units include 2 factory assembled post kits and shelves. Add-on units include 1 factory assembled post kit and shelves. Units ship complete in 1 box.

Starter

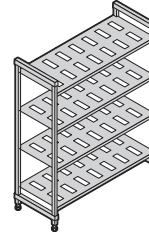

Add-On

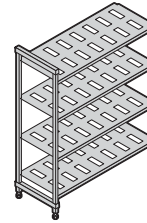

DIMENSIONS D x L x H (MM)

460 x 610 x 1830
460 x 760 x 1830
460 x 910 x 1830
460 x 1070 x 1830
460 x 1220 x 1830
460 x 1380 x 1830
460 x 1530 x 1830
460 x 1830 x 1830

CODE

CPU182472V4
CPU183072V4
CPU183672V4
CPU184272V4
CPU184872V4
CPU185472V4
CPU186072V4
CPU187272V4PKG

CODE

CPA182472V4
CPA183072V4
CPA183672V4
CPA184272V4
CPA184872V4
CPA185472V4
CPA186072V4
CPA187272V4PKG

540 x 610 x 1830
540 x 760 x 1830
540 x 910 x 1830
540 x 1070 x 1830
540 x 1220 x 1830
540 x 1380 x 1830
540 x 1530 x 1830
540 x 1830 x 1830

CPU212472V4
CPU213072V4
CPU213672V4
CPU214272V4
CPU214872V4
CPU215472V4
CPU216072V4
CPU217272V4PKG

CPA212472V4
CPA213072V4
CPA213672V4
CPA214272V4
CPA214872V4
CPA215472V4
CPA216072V4
CPA217272V4PKG

610 x 610 x 1830
610 x 760 x 1830
610 x 910 x 1830
610 x 1070 x 1830
610 x 1220 x 1830
540 x 1380 x 1830
610 x 1530 x 1830
610 x 1830 x 1830

CPU242472V4
CPU243072V4
CPU243672V4
CPU244272V4
CPU244872V4
CPU245472V4
CPU246072V4
CPU247272V4PKG

CPA242472V4
CPA243072V4
CPA243672V4
CPA244272V4
CPA244872V4
CPA245472V4
CPA246072V4
CPA247272V4PKG

PREMIUM
SERIES

2140
mm
HEIGHT

V5PKG 5-Shelf Vented Units

Due to the unit weight, 2140 mm units ship in separate boxes. Starter units include 2 post kits and 1 box of shelves. Add on units include 1 post kit and 1 box of shelves. Post kits require assembly.

Starter

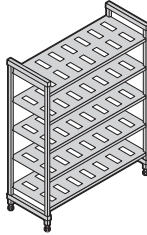

Add-On

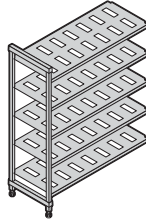

460 mm
DEPTH

DIMENSIONS D x L x H (MM)

460 x 610 x 2140
460 x 760 x 2140
460 x 910 x 2140
460 x 1070 x 2140
460 x 1220 x 2140
460 x 1380 x 2140
460 x 1530 x 2140
460 x 1830 x 2140

540 mm
DEPTH

540 x 610 x 2140
540 x 760 x 2140
540 x 910 x 2140
540 x 1070 x 2140
540 x 1220 x 2140
540 x 1380 x 2140
540 x 1530 x 2140
540 x 1830 x 2140

610 mm
DEPTH

610 x 610 x 2140
610 x 760 x 2140
610 x 910 x 2140
610 x 1070 x 2140
610 x 1220 x 2140
610 x 1380 x 2140
610 x 1530 x 2140
610 x 1830 x 2140

CODE

CPU182484V5PKG
CPU183084V5PKG
CPU183684V5PKG
CPU184284V5PKG
CPU184884V5PKG
CPU185484V5PKG
CPU186084V5PKG
CPU187284V5PKG

CODE

CPA182484V5PKG
CPA183084V5PKG
CPA183684V5PKG
CPA184284V5PKG
CPA184884V5PKG
CPA185484V5PKG
CPA186084V5PKG
CPA187284V5PKG

CPU212484V5PKG
CPU213084V5PKG
CPU213684V5PKG
CPU214284V5PKG
CPU214884V5PKG
CPU215484V5PKG
CPU216084V5PKG
CPU217284V5PKG

CPA212484V5PKG
CPA213084V5PKG
CPA213684V5PKG
CPA214284V5PKG
CPA214884V5PKG
CPA215484V5PKG
CPA216084V5PKG
CPA217284V5PKG

CPU242484V5PKG
CPU243084V5PKG
CPU243684V5PKG
CPU244284V5PKG
CPU244884V5PKG
CPU245484V5PKG
CPU246084V5PKG
CPU247284V5PKG

CPA242484V5PKG
CPA243084V5PKG
CPA243684V5PKG
CPA244284V5PKG
CPA244884V5PKG
CPA245484V5PKG
CPA246084V5PKG
CPA247284V5PKG

Color: Speckled Grey (480).

PREMIUM
SERIES

V4 4-Shelf Vented Mobile Units

Mobile starter units include 2 factory assembled mobile post kits, shelves and 4 premium swivel casters with total locking brake. Units ship complete in 1 box.

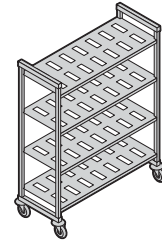

1700
mm
HEIGHT

460 mm
DEPTH

540 mm
DEPTH

610 mm
DEPTH

1910
mm
HEIGHT

460 mm
DEPTH

540 mm
DEPTH

610 mm
DEPTH

CODE DIMENSIONS D x L x H (MM)

CPMU183667V4	460 x 910 x 1700
CPMU184267V4	460 x 1070 x 1700
CPMU184867V4	460 x 1220 x 1700

CPMU213667V4	540 x 910 x 1700
CPMU214267V4	540 x 1070 x 1700
CPMU214867V4	540 x 1220 x 1700

CPMU243667V4	610 x 910 x 1700
CPMU244267V4	610 x 1070 x 1700
CPMU244867V4	610 x 1220 x 1700

CODE DIMENSIONS D x L x H mm

CPMU183675V4	460 x 910 x 1910
CPMU184275V4	460 x 1070 x 1910
CPMU184875V4	460 x 1220 x 1910

CPMU213675V4	540 x 910 x 1910
CPMU214275V4	540 x 1070 x 1910
CPMU214875V4	540 x 1220 x 1910





CPMU243675V4	610 x 910 x 1910
CPMU244275V4	610 x 1070 x 1910
CPMU244875V4	610 x 1220 x 1910



Camshelving® Premium Series Accessories

Bottom Shelf Dunnage Stands

Increase weight bearing capacity on bottom shelf only. Add to any shelf length. Highly recommended for starter units 1380 mm and longer and all corner units, intermediate units and units specified for heavier load volume on and off bottom shelves.

CODE	DIMENSIONS D x H* (MM)
Dunnage Stand - Low	
CPDS14H6	360 x 190
CPDS18H6	460 x 190
CPDS21H6	540 x 190
CPDS24H6	610 x 190
Dunnage Stand - Tall	
 CPDS14H11	360 x 289
 CPDS18H11	460 x 289
 CPDS21H11	540 x 289
 CPDS24H11	610 x 289

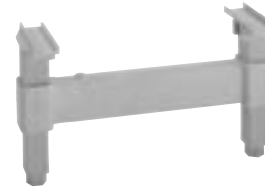
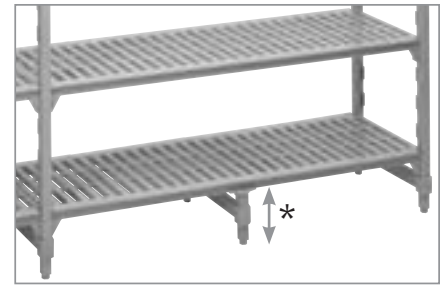

Case Pack: 1 **Color:** Speckled Grey (480).

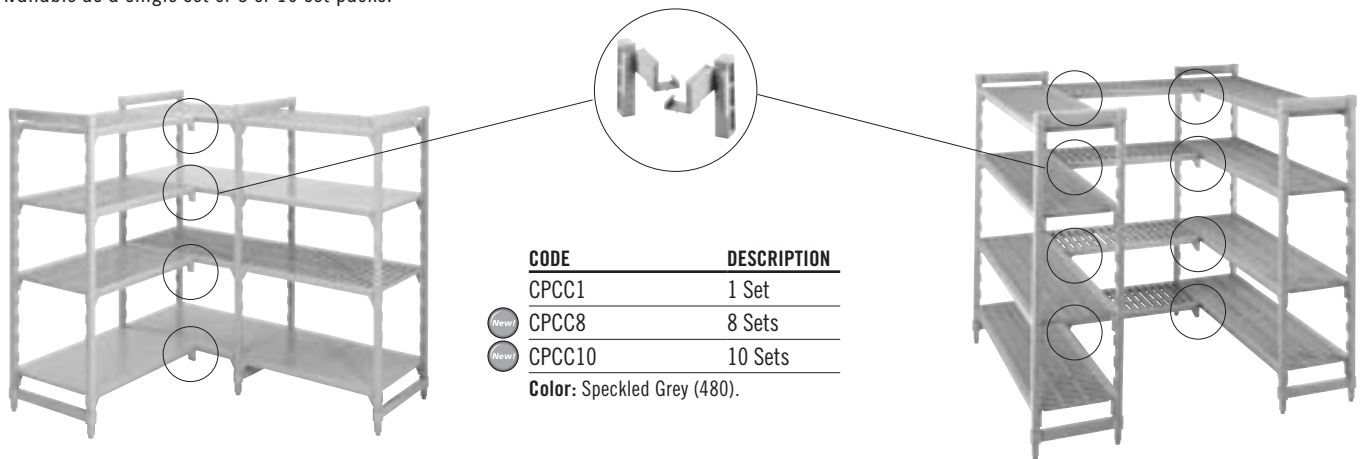

Corner Connectors

Unique patented design ensures maximum shelf space utilization. Use 1 set per shelf to connect starter and add-on units in corners. Connect 4 or 5 intermediate shelves between 2 starter units (2 sets required per shelf). Available as a single set or 8 or 10 set packs.



CODE	DESCRIPTION
CPCC1	1 Set
 CPCC8	8 Sets
 CPCC10	10 Sets

Color: Speckled Grey (480).

Identification Tags

Clip onto shelf traverses to clearly identify stored product. Made of highly durable plastic with a clear slide in front panel. Labels included.

CODE	DESCRIPTION	SIZE (MM)
CSID6	152 mm ID Tag	25 x 152
CSID3	76 mm ID Tag	25 x 76

Case Pack: 12 **Color:** White / Clear.



Wall Fastener

Use to secure stationary shelving unit to a wall for added safety and stability where required. Made of stainless steel. Screws not included.

CODE	DIMENSION D x L x H (MM)
CSWF	73 x 238 x 48

Case Pack: 4 **Color:** Silver (000).



Camshelving® Premium Series Accessories

Seismic Foot

Secure stationary unit posts directly to the floor for added safety and stability where required. Made of stainless steel. Bolts not included.

CODE	DIMENSION D x L x H (MM)
CSEQ3	102 x 83 x 59
Case Pack: 4 Color: Silver (000).	



Premium Caster

Ideal in all areas of storage, especially coolers, freezers and/or wet areas. Made of highly durable, non-corrosive plastic with a 127 mm swivel, non-marking thermoplastic rubber wheel. Total locking brake locks both swivel motion and the wheel.

CODE	SIZE (MM)
CPMCWB	127
Case Pack: 2 Color: Grey (000).	



Donut Bumper

Offers added protection during transport and when maneuvering mobile units into place against walls or alongside other units for storage.

CODE	SIZE (MM)
CSRDB	90
Case Pack: 4 Color: Grey (000).	



Shelf Divider

Stack and separate items stored on shelves. Made of highly durable ABS plastic. Installs directly onto solid or vented shelves. Easily removable for relocating or washing.

CODE	DIMENSION D x H (MM)
CSSD188	460 x 203
CSSD218	540 x 203
CSSD248	610 x 203
Case Pack: 1 Color: Soft Grey (151).	



Shelf Divider Bars (for 610 mm deep shelf only)

Create a custom service or storage station for food pans, boxes or dish racks. Install straight or angled dividers directly onto shelf traverses.

CODE	DESCRIPTION
CSDBA	Angled Divider Bar
CSDBS	Straight Divider Bar
Case Pack: 4 Color: Speckled Grey (480).	



Camshelving® Premium Series Accessories

Shelf Rails

Install onto traverses and dovetails to prevent items from falling off sides and ends of shelves. Choose from single or double rail side kits and double rail only end kits.

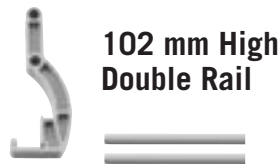

DOUBLE RAIL CODE	LENGTH (MM)
CPFL242	610
CPFL302	760
CPFL362	910
CPFL422	1070
CPFL482	1220
CPFL542	1380
CPFL602	1530
CPFL722	1830



SINGLE RAIL CODE	LENGTH (MM)
CPFL241	610
CPFL301	760
CPFL361	910
CPFL421	1070
CPFL481	1220
CPFL541	1380
CPFL601	1530
CPFL721	1830



END RAIL CODE	LENGTH (MM)
CPFE14	360
CPFE18	460
CPFE21	540
CPFE24	610

Color: Speckled Grey (480).

Tray Sliding Rack (for 610 mm deep shelf only)

Holds up to 6 each full size (1826) 46 x 66 cm or 12 half size (1318) 32 x 45 cm sheet pans or trays. Install 1 or more units onto vented shelves, any length. High quality, lightweight aluminum material is safe for use in coolers and freezers. Made from aluminum 6463 (6000 series).

CODE	DIMENSION D x L x H (MM)
CSTSR	584 x 517 x 508

Case Pack: 1 Color: Silver (000).

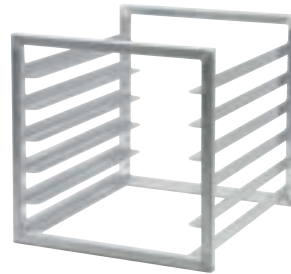

Full-Wrap Security Cage (for 610 mm deep shelf only)

Store valuable products behind locked doors. Made of heavy-duty 304 stainless steel for use in any environment. Stationary or mobile units ship complete with factory assembled post kits, 2 vented shelves, 4 premium swivel casters with total locking brake for mobile unit and 1 full wrap security cage. Assembly required. Lock not included.

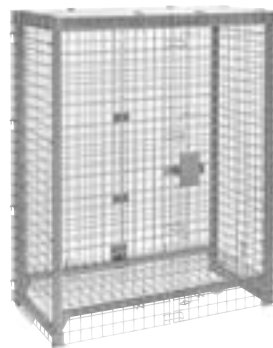

Security cage only, shelving frame not included.



Ships standard with 2 Vented Shelf Kits

CODE	CPFWSC244860	CPU244864SUPKG	CPMU244867SUPKG
DESCRIPTION	Full-wrap Security Cage only	Full-wrap Stationary Security Unit	Full-wrap Mobile Security Unit
DIMENSION D x L x H (MM)	680 x 1276 x 1562	680 x 1276 x 1638	680 x 1276 x 1721
COLOR	Silver (000)	Speckled Grey (480)	Speckled Grey (480)

Case Pack: 1

Cage only ships in  1 Units ship in  2

Camshelving® Premium Series Accessories

Single Shelf Security Cage (for 610 mm deep shelf only)

Securely store valuable products on a single shelf. Made of heavy duty, 304 stainless steel for use in any environment. Requires 457 mm height between shelves. Install on vented shelves only. Lock not included.

CODE	DIMENSION D x L x H (MM)
CSSC244818	640 x 1080 x 460

Case Pack: 1 Color: Silver (000).



Shelf Traverses

Available in single or double packs. Use a single set to add an open shelf for divider bars or drying racks. Add single traverses onto back posts for extra support when placing rolling equipment under the first shelf.

LENGTH (MM)	SINGLE PACK CODE*	DOUBLE PACK CODE**
610	CPTR24	—
760	CPTR30	—
910	CPTR36	CPTR362PK
1070	CPTR42	CPTR422PK
1220	CPTR48	CPTR482PK
1380	CPTR54	CPTR542PK
1530	CPTR60	CPTR602PK
1830	CPTR72	—

* Case Pack: 1 **Case Pack: 2
Color: Speckled Grey (480).



Vertical Drying and Storage Cradle (for 610 mm deep shelf only)

Modular 7-slot rack designed for drying and storing trays, sheet pans, cutting boards and lids. Installs directly onto shelf traverses. Made of highly durable ABS plastic. Available in single or 3 pack.

CODE	DIMENSIONS D x L x H (MM)	CASE PACK
CSDR7	597 x 260 x 95	1
CSDR73	597 x 260 x 95	3

Color: Soft Grey (151).



Vertical Drying and Storage Rack

Promotes sanitary drying, safe handling and efficient product organization with easy access to product.

Units ship complete with factory assembled mobile post kits, 6 traverses, 12 or 15 vertical drying cradles and premium swivel casters with total locking brake. Assembly required.

CODE	DIMENSIONS D x L x H (MM)	HOLDING CAPACITY
CPMU244875DRPKG	610 x 1220 x 1980	84 trays
CPMU246075DRPKG	610 x 1530 x 1980	105 trays

Color: Speckled Grey (480).

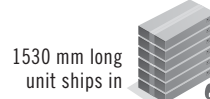

Camshelving® Premium Series Accessories

Dome Drying and Storage Cradle (for 540 mm deep shelf only)

Use to dry and safely store up to 10 patient meal delivery domes or plate covers upright. Installs directly onto shelf traverses. Made of highly durable ABS plastic. Available in single or 5 pack.

CODE	DIMENSIONS D x L x H	CASE PACK
CSDDC	520 x 415 x 86	1
CSDDC5	520 x 415 x 86	5

Color: Soft Grey (151).



Dome Drying and Storage Rack

Promotes sanitary drying, safe handling and efficient product organization with easy access to product.

Unit ships complete with factory assembled mobile post kits, 10 traverses, 10 dome drying cradles and premium swivel casters with total locking brake. Assembly required.

CODE	DIMENSIONS D x L x H (MM)	HOLDING CAPACITY
CPMU213675DDPKG	540 x 910 x 1910	100 domes

Color: Speckled Grey (480).



Ships in  3

Angled Drying and Storage Cradle (for 610 mm deep shelf only)

Uniquely designed cradle holds up to 8 each meal delivery pellets or use to dry, store and transport food pans and other commercial kitchen ware. Installs directly onto shelf traverses. Made of highly durable ABS plastic. Available in single or 4 pack.

CODE	DIMENSIONS D x L x H (MM)	CASE PACK
CSDR8	592 x 263 x 160	1
CSDR84	592 x 263 x 160	4

Color: Soft Grey (151).



Angled Drying and Storage Rack

Promotes sanitary drying, safe handling and efficient product organization with easy access to product.

Unit ships complete with factory assembled mobile post kits, 8 traverses, 16 angled drying cradles and premium swivel casters with total locking brake. Assembly required.

CODE	DIMENSIONS D x L x H (MM)	HOLDING CAPACITY
CPMU244875PDPKG	610 x 1220 x 1980	128 Pellets and Bases or 16 GN 1/1 Food Pans

Color: Speckled Grey (480).



Ships in  5

Camshelving® Premium Series

High Density Storage Floor Track System

Maximize storage capacity by creating storage aisles in all available space. This simple system is composed of stationary starter units anchored to a raised floor track system at both ends with high density mobile units installed in between. Easy to install track requires no drilling or gluing.



High Density Mobile Units are available with factory assembled post kits, vented or solid shelves and high density casters and bumpers. Full track and extension kits ship complete with required hardware. Stationary Starter Units are required to anchor the system at both ends. Choose from a wide selection (see pages 98-99).

Stationary Unit*

High Density Mobile Units

Stationary Unit



Raised Floor Track provides a smooth and level surface to easily roll mobile units. Raised track ensures dirt will not get trapped and is easy to clean. Aluminum track and stainless steel hardware are rust resistant.



Grooved casters roll easily and securely on raised track.



Raised track connects easily to the bottom of a stationary unit that works as a system anchor. No bolts, no glue or drilling into the floor are required. Easy and fast set up.

* It is recommended to use a stationary unit for every 4,6 m of track to further stabilize the system.

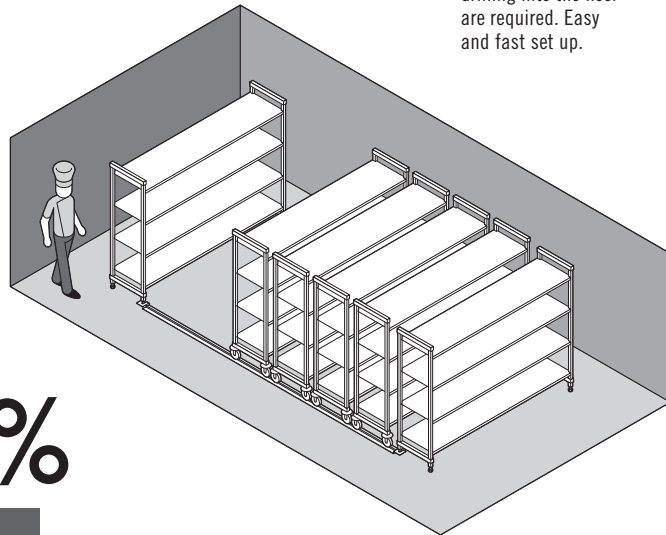
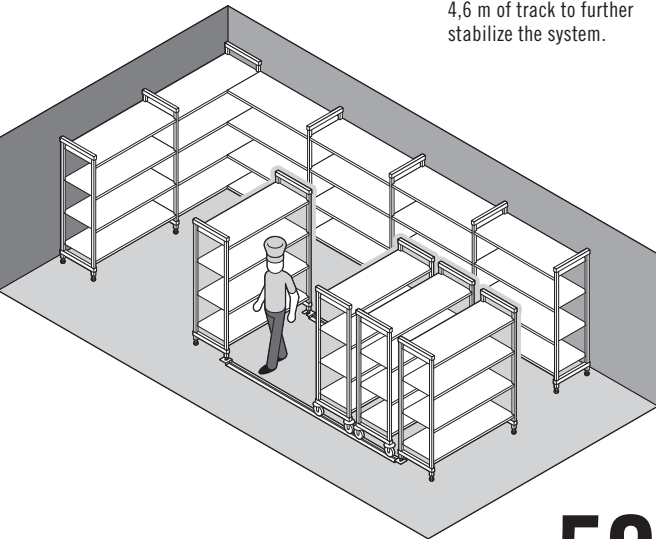

Increases Storage Capacity Up To **50%**

4-Shelf Vented High Density Mobile Starter Units

Units include 2 factory assembled mobile post kits, 4 shelves, 4 high density casters and 4 high density bumpers.

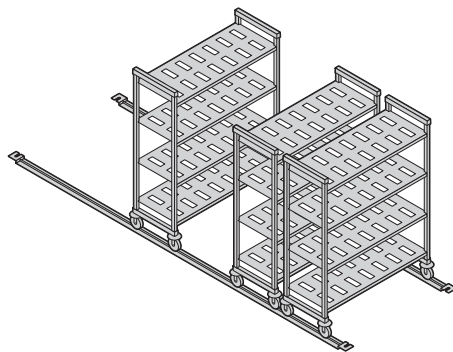

HEIGHTS*	DEPTHS	LENGTHS
2	2	5
1700 mm	540 mm	910 mm
1910	610	1070
		1220
		1380
		1530

* Includes 127 mm casters.

Ships in



4-Shelf Solid High Density Mobile Starter Units

Units include 2 factory assembled mobile post kits, 4 shelves, 4 high density casters and 4 high density bumpers.

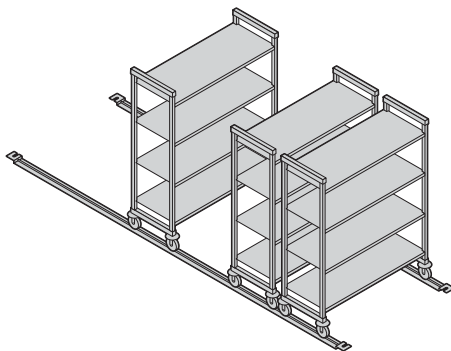

HEIGHTS*	DEPTHS	LENGTHS
2	2	5
1700 mm	540 mm	910 mm
1910	610	1070
		1220
		1380
		1530

* Includes 127 mm casters.

Ships in



Full Track and Extension Kits

Aluminum raised track kits and track extensions ship complete in 1 box. Each kit includes all stainless steel hardware necessary to complete a floor installation.

It is highly recommended to install a stationary starter unit every 4,6 m of track to further stabilize the system.

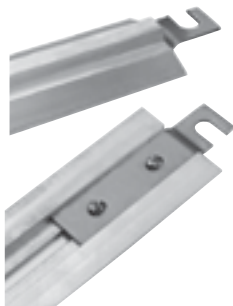

Full Track LENGTHS	Track Extension LENGTHS
3	3
3,05 m	1,38 m
3,66	1,53
4,42	1,83

Ships in



High Density Caster with Donut Bumper

Grooved caster rolls easily and securely on raised track. Donut bumper protects mobile units from coming into direct contact with each other.



V4

4-Shelf Vented High Density Mobile Units

S4

4-Shelf Solid High Density Mobile Units

Units include 2 factory assembled mobile post kits, 4 shelves, 4 high density casters and 4 high density bumpers. Units ship complete in 1 box.

1700
mm
HEIGHT

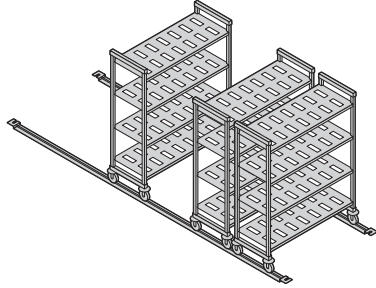

540 mm
DEPTH

CODE	DIMENSIONS D x L x H (MM)
CPHU213667V4	540 x 910 x 1700
CPHU214267V4	540 x 1070 x 1700
CPHU214867V4	540 x 1220 x 1700
CPHU215467V4	540 x 1380 x 1700
CPHU216067V4	540 x 1530 x 1700

610 mm
DEPTH

CPHU243667V4	610 x 910 x 1700
CPHU244267V4	610 x 1070 x 1700
CPHU244867V4	610 x 1220 x 1700
CPHU245467V4	610 x 1380 x 1700
CPHU246067V4	610 x 1530 x 1700

1910
mm
HEIGHT

540 mm
DEPTH

CODE	DIMENSIONS D x L x H (MM)
CPHU213675V4	540 x 910 x 1910
CPHU214275V4	540 x 1070 x 1910
CPHU214875V4	540 x 1220 x 1910
CPHU215475V4	540 x 1380 x 1910
CPHU216075V4	540 x 1530 x 1910

610 mm
DEPTH

CPHU243675V4	610 x 910 x 1910
CPHU244275V4	610 x 1070 x 1910
CPHU244875V4	610 x 1220 x 1910
CPHU245475V4	610 x 1380 x 1910
CPHU246075V4	610 x 1530 x 1910

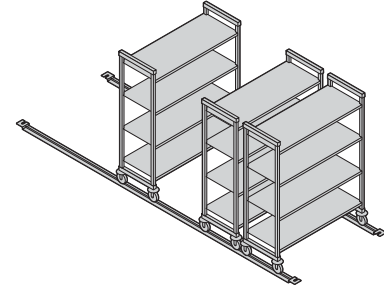

CODE	DIMENSIONS D x L x H (MM)
CPHU213667S4	540 x 910 x 1700
CPHU214267S4	540 x 1070 x 1700
CPHU214867S4	540 x 1220 x 1700
CPHU215467S4	540 x 1380 x 1700
CPHU216067S4	540 x 1530 x 1700

CPHU243667S4	610 x 910 x 1700
CPHU244267S4	610 x 1070 x 1700
CPHU244867S4	610 x 1220 x 1700
CPHU245467S4	610 x 1380 x 1700
CPHU246067S4	610 x 1530 x 1700

CODE	DIMENSIONS D x L x H (MM)
CPHU213675S4	540 x 910 x 1910
CPHU214275S4	540 x 1070 x 1910
CPHU214875S4	540 x 1220 x 1910
CPHU215475S4	540 x 1380 x 1910
CPHU216075S4	540 x 1530 x 1910



CPHU243675S4	610 x 910 x 1910
CPHU244275S4	610 x 1070 x 1910
CPHU244875S4	610 x 1220 x 1910
CPHU245475S4	610 x 1380 x 1910
CPHU246075S4	610 x 1530 x 1910

Full Track and Extension Kits

Aluminum raised track kits and track extensions ship complete in 1 box. Each kit includes all stainless steel hardware necessary to complete a floor installation.

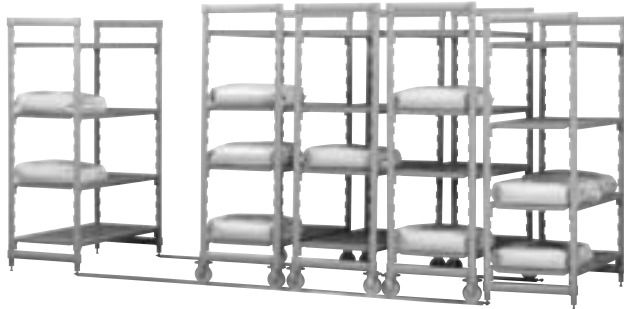
It is highly recommended to install a stationary starter unit every 4,6 m of track to further stabilize the system.



CODE	DESCRIPTION	CASE PACK
Floor Track Kit		
CSMHDTK10	3,05 m Track for 3 Mobile Units*	1
CSMHDTK12	3,66 m Track for 4 Mobile Units*	1
CSMHDTK145	4,42 m Track for 5 Mobile Units*	1
Floor Track Extension		
 CSMHDTKE4	1,38 m Track Extension	1
 CSMHDTKE5	1,53 m Track Extension	1
 CSMHDTKE6	1,83 m Track Extension	1
Accessories		
CSHDF	Floor Fastener	4

Color: Silver (000). *Based on 610 mm deep mobile units.

High Density Caster with Donut Bumper



CODE	SIZE (MM)
CPMCHD	127

Case Pack: 2 Color: Grey (000).



CAMSHELVING® ELEMENTS series

WHY CHOOSE ELEMENTS?

Made from a revolutionary, extremely strong composite material with a smooth, easy to clean surface. Elements Series is stronger than common wire shelving. It's lighter in weight than Camshelving Premium Series and totally impervious to moisture, chemicals and liquids that can destroy shelving over time. Elements Series is designed for medium to heavy storage use in freezers, coolers, dry storage or warewashing areas. It easily supports the performance demands of a busy foodservice operation.



All Environments
-38°C TO 88°C

Stationary

Mobile

camguard
ANTIMICROBIAL SHELF PLATES



Post Connectors, Corner Connectors, Seismic Foot, Wall Fastener, Identification Tags, Single Shelf Security Cage, Tray Slide Rack, and Shelf Divider Bars are not NSF Listed.

storage needs

MEDIUM to HEAVY

weekly deliveries

5 – 7

Camshelving® Elements Series Stationary Unit Sizes

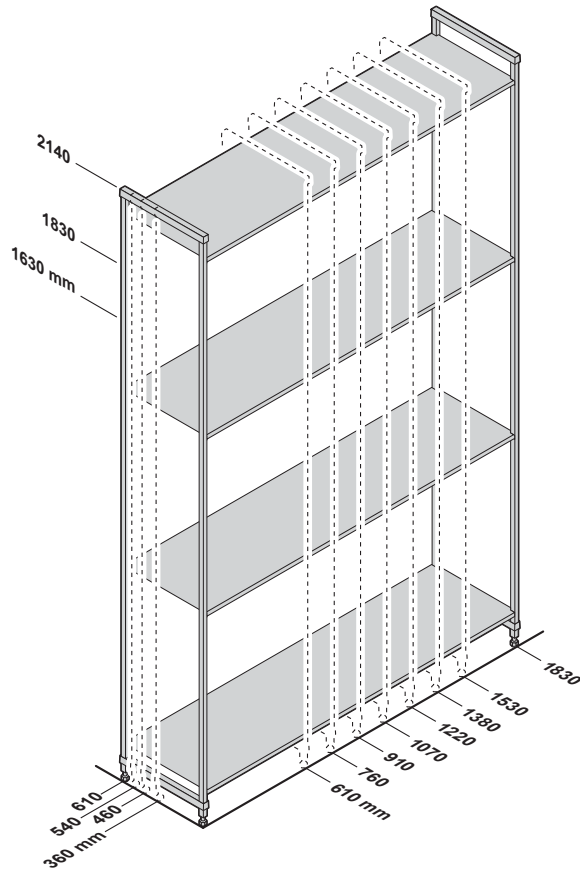

Mobile Unit Sizes

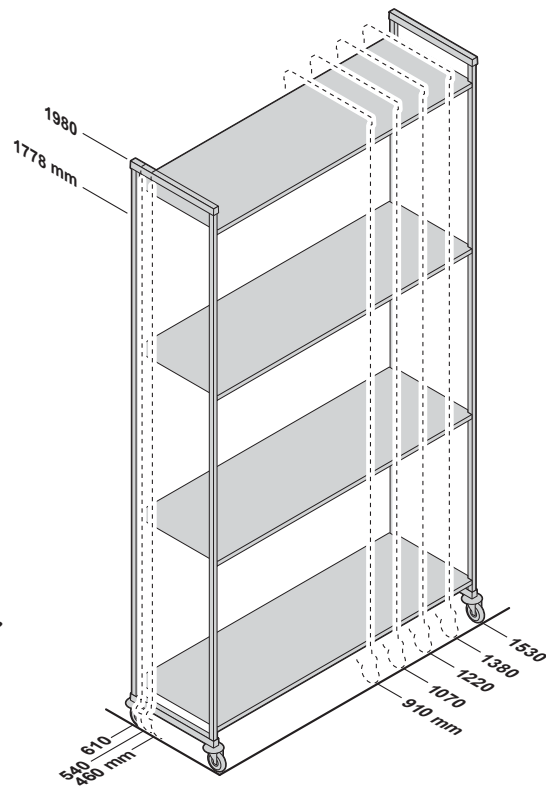

4 Shelf Unit Weight Bearing Chart

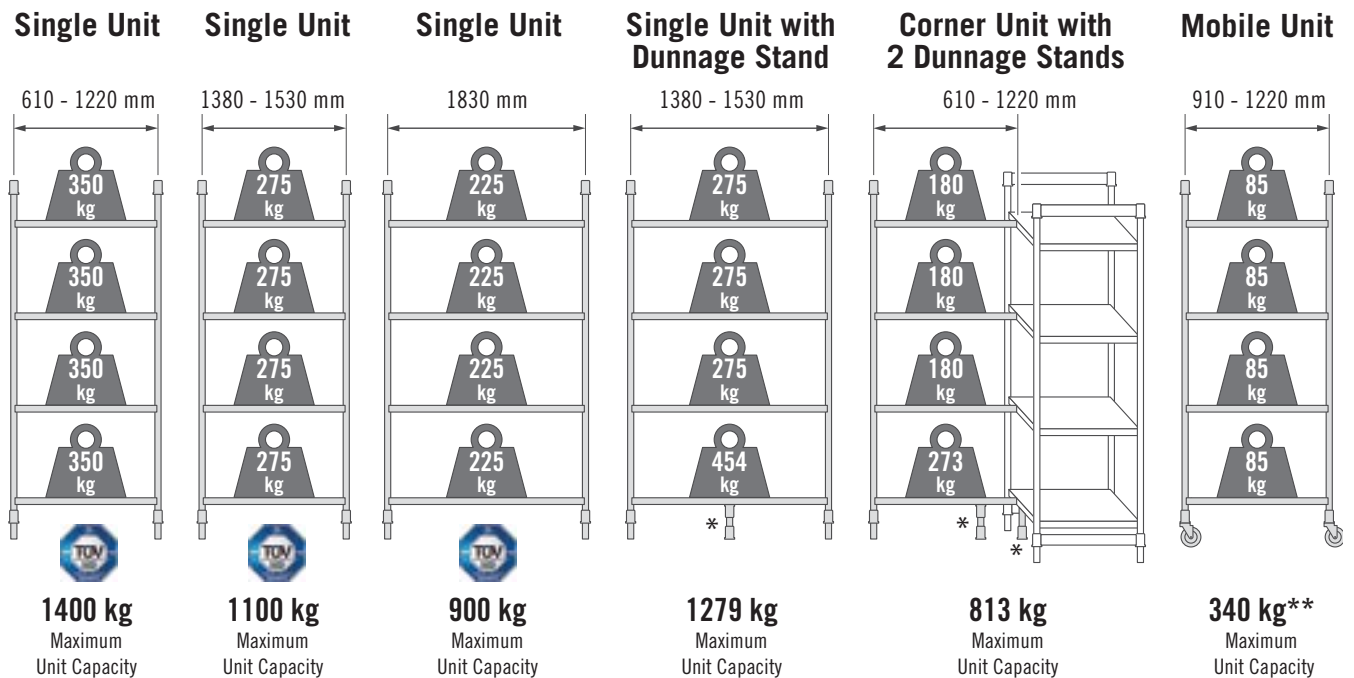

* Dunnage Stands add stability and increase weight bearing capacity on bottom shelf only. Add to any shelf length. Highly recommended for Starter Units 1380 mm and longer, all Corner Units, U-Shape Units and units specified for heavier loads (see page 92).

** Due to the weight bearing capacity of casters, maximum weight load on an entire Mobile Unit is 340 kg.

Camshelving® Elements Series

Starter, Add-On and Mobile Units

These units make ordering easy and saves time and labor during installation. Units ship complete in one box. Post kits are pre-assembled at the factory, speeding up on site set up.



4-Shelf Vented Stationary Starter and Add-On Units

Starter units include 2 factory assembled post kits and shelves.
Add-On units include 1 factory assembled post kit and shelves.

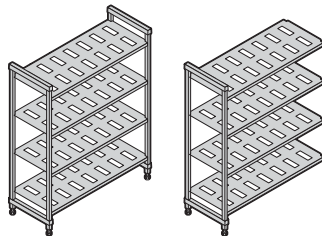

HEIGHTS	DEPTHS	LENGTHS	
3	3	8	
1630 mm	460 mm	610 mm	1220 mm
1830	540	760	1380
2140	610	910	1530
		1070	1830

Ships in  1

4-Shelf Solid Stationary Starter and Add-On Units

Starter units include 2 factory assembled post kits and shelves.
Add-On units include 1 factory assembled post kit and shelves.

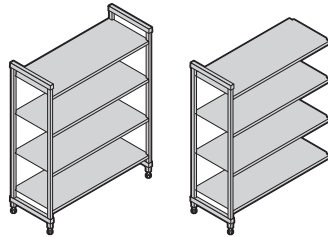

HEIGHTS	DEPTHS	LENGTHS	
3	3	8	
1630 mm	460 mm	610 mm	1220 mm
1830	540	760	1380
2140	610	910	1530
		1070	1830

Ships in  1

4-Shelf Vented and Solid Stationary Starter and Add-On Units (3 vented + 1 solid)

Starter units include 2 factory assembled post kits and shelves.
Add-On units include 1 factory assembled post kit and shelves.
Install solid shelf on bottom to prevent water/cleaning solutions from sloshing up onto stored products. Install solid shelf on top to protect product stored on lower shelves from condensation in cooler.

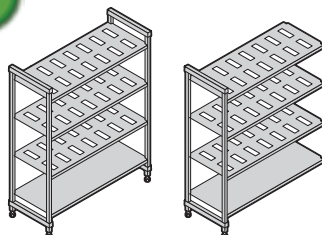

HEIGHTS	DEPTHS	LENGTHS	
3	3	8	
1630 mm	460 mm	610 mm	1220 mm
1830	540	760	1380
2140	610	910	1530
		1070	1830

Ships in  1

5-Shelf Vented Stationary Starter and Add-On Units

Starter units include 2 factory assembled post kits and shelves.

Add-On units include 1 factory assembled post kit and shelves.

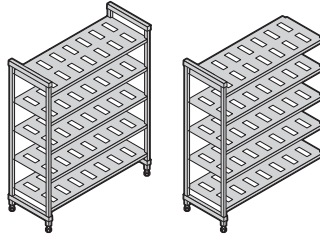

HEIGHTS	DEPTHS	LENGTHS	
3	3	8	
1630 mm	460 mm	610 mm	1220 mm
1830	540	760	1380
2140	610	910	1530
		1070	1830

Ships in  4

5-Shelf Solid Stationary Starter and Add-On Units

Starter units include 2 factory assembled post kits and shelves.

Add-On units include 1 factory assembled post kit and shelves.

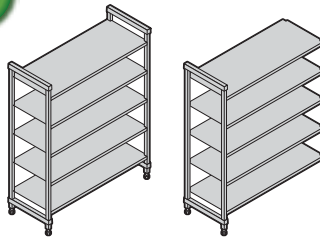

HEIGHT	DEPTHS	LENGTHS	
1	3	8	
2140 mm	460 mm	610 mm	1220 mm
	540	760	1380
	610	910	1530
		1070	1830

Ships in  4

5-Shelf Vented and Solid Stationary Starter And Add-On Units (4 vented + 1 solid)

Starter units include 2 factory assembled post kits and shelves.

Add-On units include 1 factory assembled post kit and shelves.

Install solid shelf on bottom to prevent water/cleaning solutions from sloshing up onto stored products.
Install solid shelf on top to protect product stored on lower shelves from condensation in cooler.

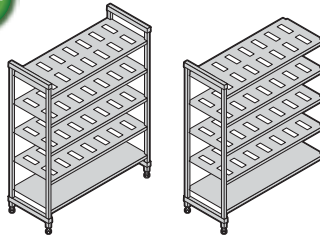

HEIGHT	DEPTHS	LENGTHS	
1	3	8	
2140 mm	460 mm	610 mm	1220 mm
	540	760	1380
	610	910	1530
		1070	1830

Ships in  4

4 or 5-Shelf Vented Mobile Starter Units

Mobile starter units include 2 factory assembled mobile post kits, shelves and 4 premium swivel casters with total locking brake.

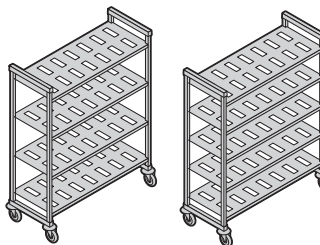

HEIGHTS*	DEPTHS	LENGTHS	
2	3	5	
1778 mm	460 mm	910 mm	1380 mm
1980	540	1070	1530
	610	1220	

* Includes 127 mm casters.

Ships in  4



Visit the Camshelving Microsite at www.cambro.com/camshelving for product information and pricing on ALL available shelving products. View or download the Camshelving Specification and Price List. Or scan QR code.

ELEMENTS
SERIES

V4 4-Shelf Vented Units

1630
mm
HEIGHT

Starter units include 2 factory assembled stationary post kits, stationary traverses, stationary traverse dovetails and shelf plates. Add-On units include 1 factory assembled stationary post kit, stationary traverses, stationary traverse dovetails and shelf plates. Units ship complete in 1 box.

Starter

Add-On

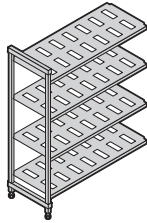
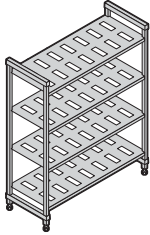

460 mm
DEPTH

DIMENSIONS D x L x H (MM)
460 x 610 x 1630
460 x 760 x 1630
460 x 910 x 1630
460 x 1070 x 1630
460 x 1220 x 1630
460 x 1380 x 1630
460 x 1530 x 1630
460 x 1830 x 1630

CODE
ESU182464V4
ESU183064V4
ESU183664V4
ESU184264V4
ESU184864V4
ESU185464V4
ESU186064V4
ESU187264V4

CODE
EA182464V4
EA183064V4
EA183664V4
EA184264V4
EA184864V4
EA185464V4
EA186064V4
EA187264V4

540 mm
DEPTH

540 x 610 x 1630
540 x 760 x 1630
540 x 910 x 1630
540 x 1070 x 1630
540 x 1220 x 1630
540 x 1380 x 1630
540 x 1530 x 1630
540 x 1830 x 1630

ESU212464V4
ESU213064V4
ESU213664V4
ESU214264V4
ESU214864V4
ESU215464V4
ESU216064V4
ESU217264V4

EA212464V4
EA213064V4
EA213664V4
EA214264V4
EA214864V4
EA215464V4
EA216064V4
EA217264V4

610 mm
DEPTH

610 x 610 x 1630
610 x 760 x 1630
610 x 910 x 1630
610 x 1070 x 1630
610 x 1220 x 1630
610 x 1380 x 1630
610 x 1530 x 1630
610 x 1830 x 1630

ESU242464V4
ESU243064V4
ESU243664V4
ESU244264V4
ESU244864V4
ESU245464V4
ESU246064V4
ESU247264V4

EA242464V4
EA243064V4
EA243664V4
EA244264V4
EA244864V4
EA245464V4
EA246064V4
EA247264V4

ELEMENTS
SERIES

V4 4-Shelf Vented Units

1830
mm
HEIGHT

Starter units include 2 factory assembled stationary post kits, stationary traverses, stationary traverse dovetails and shelf plates. Add-On units include 1 factory assembled stationary post kit, stationary traverses, stationary traverse dovetails and shelf plates. Units ship complete in 1 box.

Starter

Add-On

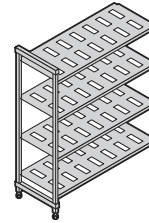
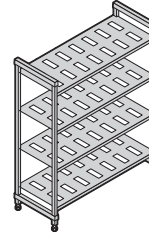

DIMENSIONS D x L x H (MM)
460 x 610 x 1830
460 x 760 x 1830
460 x 910 x 1830
460 x 1070 x 1830
460 x 1220 x 1830
460 x 1380 x 1830
460 x 1530 x 1830
460 x 1830 x 1830

CODE
ESU182472V4
ESU183072V4
ESU183672V4
ESU184272V4
ESU184872V4
ESU185472V4
ESU186072V4
ESU187272V4

CODE
EA182472V4
EA183072V4
EA183672V4
EA184272V4
EA184872V4
EA185472V4
EA186072V4
EA187272V4

540 x 610 x 1830
540 x 760 x 1830
540 x 910 x 1830
540 x 1070 x 1830
540 x 1220 x 1830
540 x 1380 x 1830
540 x 1530 x 1830
540 x 1830 x 1830

ESU212472V4
ESU213072V4
ESU213672V4
ESU214272V4
ESU214872V4
ESU215472V4
ESU216072V4
ESU217272V4

EA212472V4
EA213072V4
EA213672V4
EA214272V4
EA214872V4
EA215472V4
EA216072V4
EA217272V4

610 x 610 x 1830
610 x 760 x 1830
610 x 910 x 1830
610 x 1070 x 1830
610 x 1220 x 1830
610 x 1380 x 1830
610 x 1530 x 1830
610 x 1830 x 1830

ESU242472V4
ESU243072V4
ESU243672V4
ESU244272V4
ESU244872V4
ESU245472V4
ESU246072V4
ESU247272V4

EA242472V4
EA243072V4
EA243672V4
EA244272V4
EA244872V4
EA245472V4
EA246072V4
EA247272V4

Color: Brushed Graphite (580).

ELEMENTS
SERIES

2140
mm
HEIGHT

V5

5-Shelf Vented Units

Starter units include 2 factory assembled stationary post kits, stationary traverses, stationary traverse dovetails and shelf plates. Add-On units include 1 factory assembled stationary post kit, stationary traverses, stationary traverse dovetails and shelf plates. Units ship complete in 1 box.

Starter

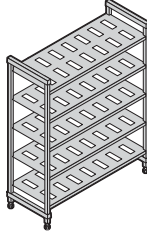

460 mm
DEPTH

DIMENSIONS D x L x H (MM)
460 x 610 x 2140
460 x 760 x 2140
460 x 910 x 2140
460 x 1070 x 2140
460 x 1220 x 2140
460 x 1380 x 2140
460 x 1530 x 2140
460 x 1830 x 2140

540 mm
DEPTH

540 x 610 x 2140
540 x 760 x 2140
540 x 910 x 2140
540 x 1070 x 2140
540 x 1220 x 2140
540 x 1380 x 2140
540 x 1530 x 2140
540 x 1830 x 2140

610 mm
DEPTH

610 x 610 x 2140
610 x 760 x 2140
610 x 910 x 2140
610 x 1070 x 2140
610 x 1220 x 2140
610 x 1380 x 2140
610 x 1530 x 2140
610 x 1830 x 2140

CODE
ESU182484V5
ESU183084V5
ESU183684V5
ESU184284V5
ESU184884V5
ESU185484V5
ESU186084V5
ESU187284V5

ESU212484V5
ESU213084V5
ESU213684V5
ESU214284V5
ESU214884V5
ESU215484V5
ESU216084V5
ESU217284V5

ESU242484V5
ESU243084V5
ESU243684V5
ESU244284V5
ESU244884V5
ESU245484V5
ESU246084V5
ESU247284V5

Add-On

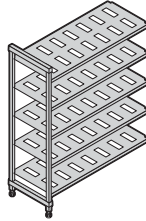

CODE
EA182484V5
EA183084V5
EA183684V5
EA184284V5
EA184884V5
EA185484V5
EA186084V5
EA187284V5

EA212484V5
EA213084V5
EA213684V5
EA214284V5
EA214884V5
EA215484V5
EA216084V5
EA217284V5

EA242484V5
EA243084V5
EA243684V5
EA244284V5
EA244884V5
EA245484V5
EA246084V5
EA247284V5

Color: Brushed Graphite (580).

ELEMENTS
SERIES

V4

4-Shelf Vented Mobile Units

Mobile units include 2 factory assembled mobile post kits, mobile traverses, mobile traverse dovetails, shelf plates, and 4 premium swivel casters with total locking brake. Units ship complete in 1 box.

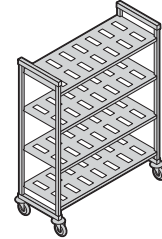

1778
mm
HEIGHT

460 mm
DEPTH

540 mm
DEPTH

610 mm
DEPTH

1980
mm
HEIGHT

460 mm
DEPTH

540 mm
DEPTH

610 mm
DEPTH

CODE	DIMENSIONS D x L x H (MM)
EMU183670V4	460 x 910 x 1778
EMU184270V4	460 x 1070 x 1778
EMU184870V4	460 x 1220 x 1778
EMU185470V4	460 x 1380 x 1778
EMU186070V4	460 x 1530 x 1778
EMU213670V4	540 x 910 x 1778
EMU214270V4	540 x 1070 x 1778
EMU214870V4	540 x 1220 x 1778
EMU215470V4	540 x 1380 x 1778
EMU216070V4	540 x 1530 x 1778
EMU243670V4	610 x 910 x 1778
EMU244270V4	610 x 1070 x 1778
EMU244870V4	610 x 1220 x 1778
EMU245470V4	610 x 1380 x 1778
EMU246070V4	610 x 1530 x 1778

EMU183678V4	460 x 910 x 1980
EMU184278V4	460 x 1070 x 1980
EMU184878V4	460 x 1220 x 1980
EMU185478V4	460 x 1380 x 1980
EMU186078V4	460 x 1530 x 1980

EMU213678V4	460 x 910 x 1980
EMU214278V4	460 x 1070 x 1980
EMU214878V4	460 x 1220 x 1980
EMU215478V4	460 x 1380 x 1980
EMU216078V4	460 x 1530 x 1980

EMU243678V4	460 x 910 x 1980
EMU244278V4	460 x 1070 x 1980
EMU244878V4	460 x 1220 x 1980
EMU245478V4	460 x 1380 x 1980
EMU246078V4	460 x 1530 x 1980







Camshelving® Elements Series Accessories

Bottom Shelf Dunnage Stands

Increase weight bearing capacity on bottom shelf only. Add to any shelf length. Highly recommended for starter units 1380 mm and longer and all corner units, intermediate units and units specified for heavier load volume on and off bottom shelves.

CODE	DIMENSIONS D x H* (MM)
Dunnage Stand - Low	
EDS14H6	360 x 165
EDS18H6	460 x 165
EDS21H6	540 x 165
EDS24H6	610 x 165

Dunnage Stand - Tall	
 EDS14H10	360 x 267
 EDS18H10	460 x 267
 EDS21H10	540 x 267
 EDS24H10	610 x 267

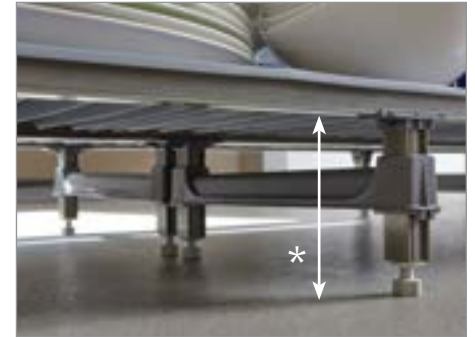

Case Pack: 1
Color: Brushed Graphite (580).

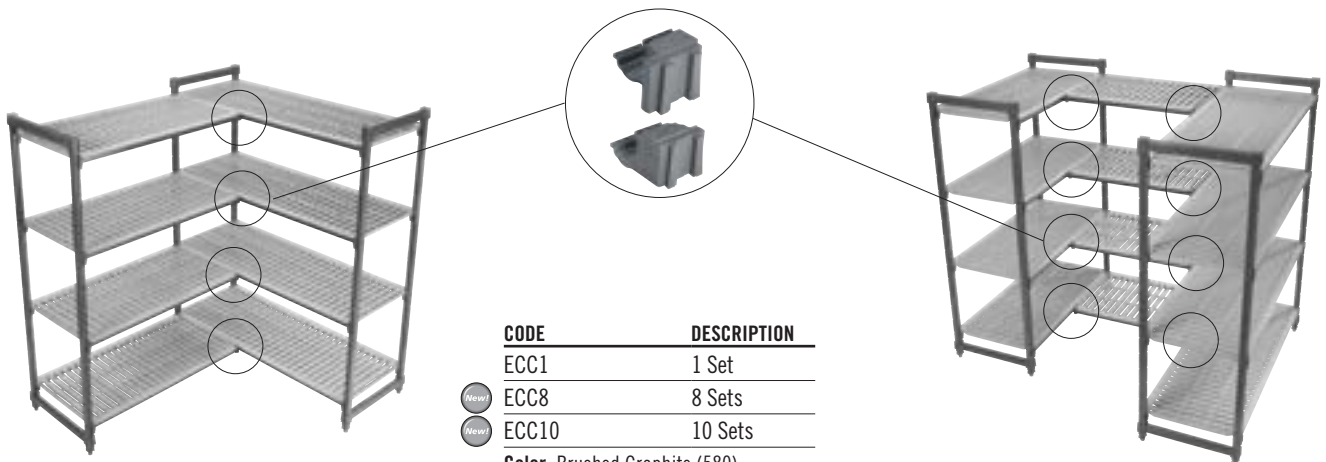

Corner Connectors

Unique patented design ensures maximum shelf space utilization. Use 1 set per shelf to connect starter and add-on units in corners. Connect 4 or 5 intermediate shelves between 2 starter units (2 sets required per shelf). Available as a single set or 8 or 10 set packs.



CODE	DESCRIPTION
ECC1	1 Set
 ECC8	8 Sets
 ECC10	10 Sets

Color: Brushed Graphite (580).

Camshelving® Elements Series Accessories

Identification Tags

Clip onto shelf traverses to clearly identify stored product. Made of highly durable plastic with a clear slide in front panel. Labels included.

CODE	DESCRIPTION	DIMENSION H x L (MM)
CSID6	152 mm ID Tag	25 x 152
CSID3	76 mm ID Tag	25 x 76

Case Pack: 12 **Color:** White / Clear.



Wall Fastener

Use to secure stationary shelving unit to a wall for added safety and stability where required. Made of stainless steel. Screws not included.

CODE	DIMENSION D x L x H (MM)
CSWF	73 x 238 x 48

Case Pack: 4 **Color:** Silver (000).



Seismic Foot

Secure stationary unit posts directly to the floor for added safety and stability where required. Made of stainless steel. Bolts not included.

CODE	DIMENSION D x L x H (MM)
CSEQ3	102 x 83 x 59

Case Pack: 4 **Color:** Silver (000).



Premium Caster

Ideal in all areas of storage, especially coolers, freezers and/or wet areas. Made of highly durable, non-corrosive plastic with a 127 mm swivel, non-marking thermoplastic rubber wheel. Total locking brake locks both swivel motion and the wheel.

CODE	SIZE (MM)
EMCWB	127

Case Pack: 2 **Color:** Grey (000).



Camshelving® Elements Series Accessories

Donut Bumper

Offers added protection during transport and when maneuvering mobile units into place against walls or alongside other units for storage.

CODE	SIZE (MM)
CSMHDDB	127

Case Pack: 4 **Color:** Grey (000).



Shelf Divider

Stack and separate items stored on shelves. Made of highly durable ABS plastic. Installs directly onto solid or vented shelves. Easily removable for relocating or washing.

CODE	DIMENSION D x H (MM)
CSSD188	460 x 203
CSSD218	540 x 203
CSSD248	610 x 203

Case Pack: 1 **Color:** Soft Grey (151).



Shelf Divider Bars (for 610 mm deep shelf only)

Create a custom service or storage station for food pans, boxes or dish racks. Install straight or angled dividers directly onto shelf traverses.

CODE	DESCRIPTION
EDBA	Angled Divider Bar
EDBS	Straight Divider Bar

Case Pack: 4 **Color:** Speckled Grey (480).



Tray Sliding Rack (for 610 mm deep shelf only)

Holds up to 6 each full size (1826) 46 x 66 cm or 12 half size (1318) 32 x 45 cm sheet pans or trays. Install 1 or more units onto vented shelves, any length. High quality, lightweight aluminum material is safe for use in coolers and freezers. Made from aluminum 6463 (6000 series).

CODE	DIMENSION D x L x H (MM)
CSTSR	584 x 517 x 508

Case Pack: 1 **Color:** Silver (000).

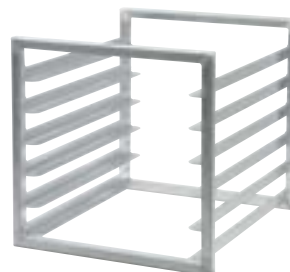

Camshelving® Elements Series Accessories

Single Shelf Security Cage (for 610 mm deep shelf only)

Securely store valuable products on a single shelf. Made of heavy duty, 304 stainless steel for use in any environment. Requires 457 mm height between shelves. Install on vented shelves only. Lock not included.

CODE	DIMENSION D x L x H (MM)
CSSC244818	640 x 1080 x 460
Case Pack: 1 Color: Silver (000).	



Shelf Traverses

Available in single or double packs, stationary or mobile. Use two traverses to add an open shelf for divider bars or drying cradles. Add one stationary traverse onto back posts of a stationary unit for extra support when placing rolling equipment under the first shelf. Traverse dovetails included.

Stationary Traverse

LENGTH (MM)	SINGLE PACK CODE*	DOUBLE PACK CODE**
610	ETR24	—
760	ETR30	—
910	ETR36	ETR362PK
1070	ETR42	ETR422PK
1220	ETR48	ETR482PK
1380	ETR54	ETR542PK
1530	ETR60	ETR602PK
1830	ETR72	—

*Case Pack: 1 **Case Pack: 2
Color: Brushed Graphite (580).



Stationary
Traverse

Mobile Traverse

LENGTH (MM)	SINGLE PACK CODE*	DOUBLE PACK CODE**
910	EMTR36	EMTR362PK
1070	EMTR42	EMTR422PK
1220	EMTR48	EMTR482PK
1380	EMTR54	EMTR542PK
1530	EMTR60	EMTR602PK

*Case Pack: 1 **Case Pack: 2
Color: Brushed Graphite (580).



Mobile
Traverse

Dome Drying and Storage Cradle (for 540 mm deep shelf only)

Use to dry and safely store up to 10 patient meal delivery domes or plate covers upright. Installs directly onto shelf traverses. Made of highly durable ABS plastic. Available in single or 5 pack.

CODE	DIMENSIONS D x L x H (MM)	CASE PACK
CSDDC	520 x 415 x 86	1
CSDDC5	520 x 415 x 86	5
Color: Soft Grey (151).		



Camshelving® Elements Series Accessories

Vertical Drying and Storage Cradle (for 610 mm deep shelf only)

Modular 7-slot rack designed for drying and storing trays, sheet pans, cutting boards and lids. Installs directly onto shelf traverses. Made of highly durable ABS plastic. Available in single or 3 pack.

CODE	DIMENSIONS D x L x H (MM)	CASE PACK
CSDR7	597 x 260 x 95	1
CSDR73	597 x 260 x 95	3

Color: Soft Grey (151).



Vertical Drying and Storage Rack

Promotes sanitary drying, safe handling and efficient product organization with easy access to product.

Units ship complete with factory assembled mobile post kits, 6 mobile shelf traverses, mobile shelf traverse dovetails, 12 or 15 vertical drying cradles and premium swivel casters with total locking brake. Assembly required.

CODE	DIMENSIONS D x L x H (MM)	HOLDING CAPACITY
EMU244878DRPKG	610 x 1220 x 1980	84 trays
EMU246078DRPKG	610 x 1530 x 1980	105 trays

Color: Brushed Graphite (580).



1220 mm long unit ships in



5

1530 mm long unit ships in

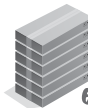

6

Angled Drying and Storage Cradle (for 610 mm deep shelf only)

Uniquely designed cradle holds up to 8 each meal delivery pellets or use to dry, store and transport food pans and other commercial kitchen ware. Installs directly onto shelf traverses. Made of highly durable ABS plastic. Available in single or 4 pack.

CODE	DIMENSIONS D x L x H (MM)	CASE PACK
CSDR8	592 x 263 x 160	1
CSDR84	592 x 263 x 160	4

Color: Soft Grey (151).



Angled Drying and Storage Rack

Promotes sanitary drying, safe handling and efficient product organization with easy access to product.

Unit ships complete with factory assembled mobile post kits, 8 mobile shelf traverses, mobile shelf traverse dovetails, 16 angled drying cradles and premium swivel casters with total locking brake. Assembly required.

CODE	DIMENSIONS D x L x H (MM)	HOLDING CAPACITY
EMU244878PDPKG	610 x 1220 x 1980	128 Pellets and Bases or 16 GN 1/1 Food Pans

Color: Brushed Graphite (580).



Ships in



5

CAMSHELVING® **BASICS** series

WHY CHOOSE BASICS?

Just because the budget is tight and storage needs are less rigorous, it doesn't mean that shelving performance and storage efficiencies should be compromised. Basics Series is made from the same high performing, strong composite material as Elements Series and has the same design features. It's lighter in weight and less in cost but still strong enough to handle light to medium storage demands.



All Environments
-38°C TO 88°C

Stationary



COMPONENT



Post Connectors, Corner Connectors, Seismic Foot, Wall Fastener, Identification Tags, Single Shelf Security Cage, and Tray Slide Rack are not NSF Listed.

storage needs
LIGHT to MEDIUM

weekly deliveries

2 – 5

Camshelving® Basics Series Stationary Unit Sizes

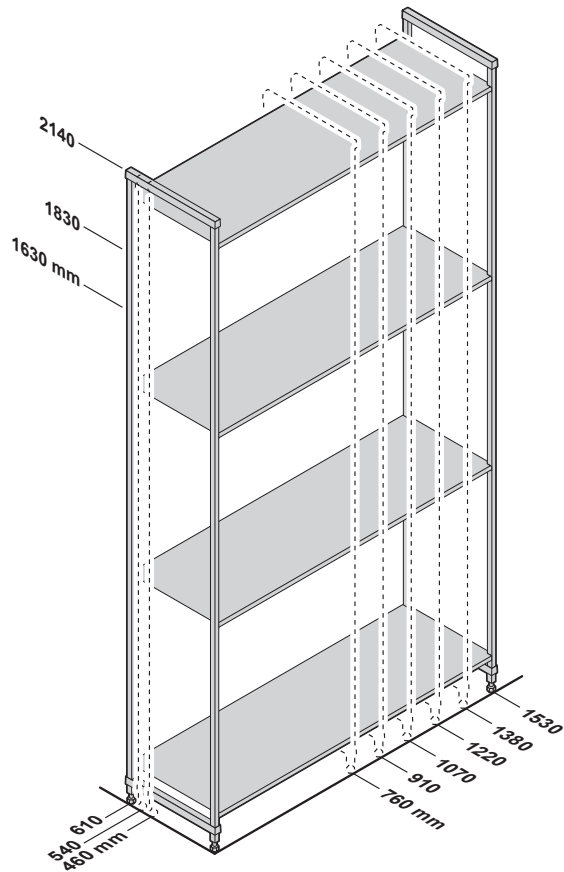

4 Shelf Unit Weight Bearing Chart

Single Unit

760 - 910 mm

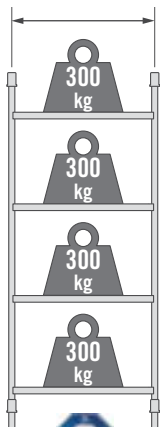

1200 kg
Maximum
Unit Capacity

Single Unit

1070 - 1220 mm

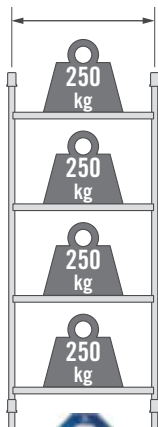

1000 kg
Maximum
Unit Capacity

Single Unit

1380 - 1530 mm

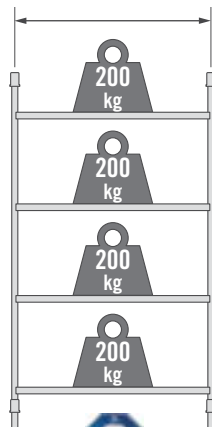

800 kg
Maximum
Unit Capacity

Single Unit with Dunnage Stand

1380 - 1530 mm

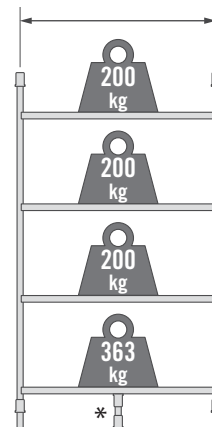

963 kg
Maximum
Unit Capacity

Corner Unit with 2 Dunnage Stands

760 - 1220 mm

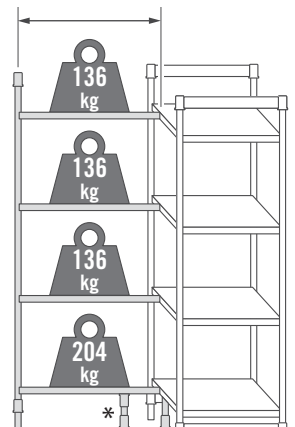

612 kg
Maximum
Unit Capacity

* Dunnage Stands add stability and increase weight bearing capacity on bottom shelf only. Add to any shelf length. Highly recommended for Starter Units 1380 mm and longer, all Corner Units, U-Shape Units and units specified for heavier loads (see page 92).

Camshelving® Basics Series

Starter, and Add-On Units

These units make ordering easy and saves time and labor during installation. Units ship complete in one box. Post kits are pre-assembled at the factory, speeding up on site set up.



4-Shelf Vented Stationary Starter and Add-On Units

Starter units include 2 factory assembled post kits and shelves.

Add-On units include 1 factory assembled post kit and shelves.

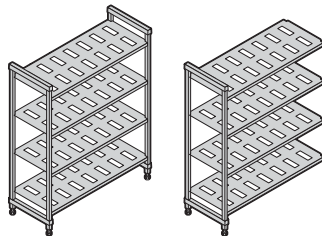

HEIGHTS	DEPTHS	LENGTHS
3	3	6
1630 mm	460 mm	760 mm 1220 mm
1830	540	910 1380
2140	610	1070 1530

Ships in  1

4-Shelf Solid Stationary Starter and Add-On Units

Starter units include 2 factory assembled post kits and shelves.

Add-On units include 1 factory assembled post kit and shelves.

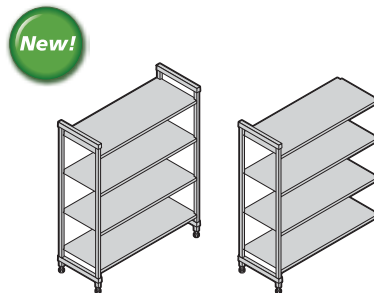

HEIGHTS	DEPTHS	LENGTHS
3	3	6
1630 mm	460 mm	760 mm 1220 mm
1830	540	910 1380
2140	610	1070 1530

Ships in  1

4-Shelf Vented and Solid Stationary Starter and Add-On Units (3 vented + 1 solid)

Starter units include 2 factory assembled post kits and shelves.

Add-On units include 1 factory assembled post kit and shelves.

Install solid shelf on bottom to prevent water/cleaning solutions from sloshing up onto stored products. Install solid shelf on top to protect product stored on lower shelves from condensation in cooler.

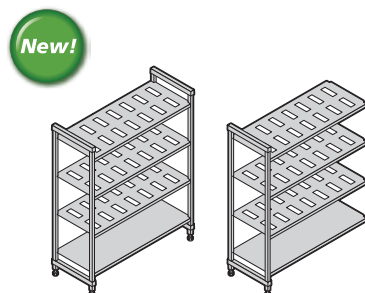

HEIGHTS	DEPTHS	LENGTHS
3	3	6
1630 mm	460 mm	760 mm 1220 mm
1830	540	910 1380
2140	610	1070 1530

Ships in  1

5-Shelf Vented Stationary Starter and Add-On Units

Starter units include 2 factory assembled post kits and shelves.

Add-On units include 1 factory assembled post kit and shelves.

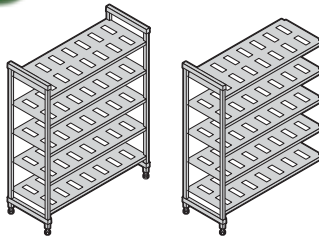

HEIGHTS	DEPTHS	LENGTHS	
3	3	6	
1630 mm	460 mm	760 mm	1220 mm
1830	540	910	1380
2140	610	1070	1530

Ships in 1

5-Shelf Solid Stationary Starter and Add-On Units

Starter units include 2 factory assembled post kits and shelves.

Add-On units include 1 factory assembled post kit and shelves.

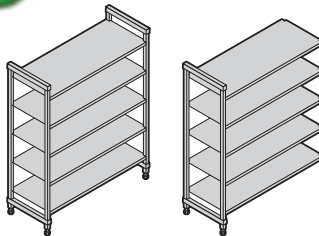

HEIGHT	DEPTHS	LENGTHS	
1	3	6	
2140 mm	460 mm	760 mm	1220 mm
	540	910	1380
	610	1070	1530

Ships in 1

5-Shelf Vented and Solid Stationary Starter And Add-On Units (4 vented + 1 solid)

Starter units include 2 factory assembled post kits and shelves.

Add-On units include 1 factory assembled post kit and shelves.

Install solid shelf on bottom to prevent water/cleaning solutions from sloshing up onto stored products.

Install solid shelf on top to protect product stored on lower shelves from condensation in cooler.

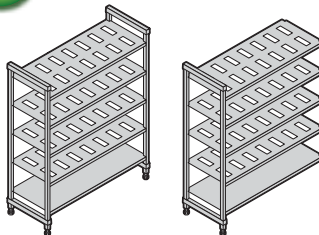

HEIGHT	DEPTHS	LENGTHS	
1	3	6	
2140 mm	460 mm	760 mm	1220 mm
	540	910	1380
	610	1070	1530

Ships in 1



Visit the Camshelving Microsite at www.cambro.com/camshelving for product information and pricing on ALL available shelving products. View or download the Camshelving Specification and Price List. Or scan QR code.

BASICS
SERIES

V4 4-Shelf Vented Units

1630
mm
HEIGHT

Starter units include 2 factory assembled post kits and shelves. Add-on units include 1 factory assembled post kit and shelves. Units ship complete in 1 box.

Starter

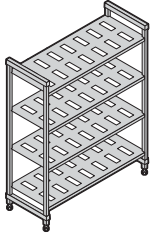

Add-On

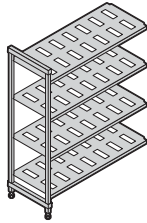

460 mm
DEPTH

DIMENSIONS
D x L x H (MM)

460 x 760 x 1630
460 x 910 x 1630
460 x 1070 x 1630
460 x 1220 x 1630
460 x 1380 x 1630
460 x 1530 x 1630

CODE

CBU183064V4
CBU183664V4
CBU184264V4
CBU184864V4
CBU185464V4
CBU186064V4

CODE

CBA183064V4
CBA183664V4
CBA184264V4
CBA184864V4
CBA185464V4
CBA186064V4

540 mm
DEPTH

540 x 760 x 1630
540 x 910 x 1630
540 x 1070 x 1630
540 x 1220 x 1630
540 x 1380 x 1630
540 x 1530 x 1630

CBU213064V4
CBU213664V4
CBU214264V4
CBU214864V4
CBU215464V4
CBU216064V4

CBA213064V4
CBA213664V4
CBA214264V4
CBA214864V4
CBA215464V4
CBA216064V4

610 mm
DEPTH

610 x 760 x 1630
610 x 910 x 1630
610 x 1070 x 1630
610 x 1220 x 1630
610 x 1380 x 1630
610 x 1530 x 1630

CBU243064V4
CBU243664V4
CBU244264V4
CBU244864V4
CBU245464V4
CBU246064V4

CBA243064V4
CBA243664V4
CBA244264V4
CBA244864V4
CBA245464V4
CBA246064V4

Color: Brushed Graphite (580).

BASICS
SERIES

V4 4-Shelf Vented Units

1830
mm
HEIGHT

Starter units include 2 factory assembled post kits and shelves. Add-on units include 1 factory assembled post kit and shelves. Units ship complete in 1 box.

Starter

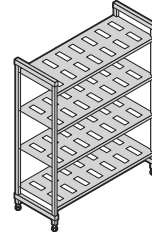

Add-On

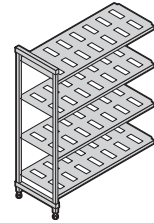

DIMENSIONS
D x L x H (MM)

460 x 760 x 1830
460 x 910 x 1830
460 x 1070 x 1830
460 x 1220 x 1830
460 x 1380 x 1830
460 x 1530 x 1830

CODE

CBU183072V4
CBU183672V4
CBU184272V4
CBU184872V4
CBU185472V4
CBU186072V4

CODE

CBA183072V4
CBA183672V4
CBA184272V4
CBA184872V4
CBA185472V4
CBA186072V4

540 x 760 x 1830
540 x 910 x 1830
540 x 1070 x 1830
540 x 1220 x 1830
540 x 1380 x 1830
540 x 1530 x 1830

CBU213072V4
CBU213672V4
CBU214272V4
CBU214872V4
CBU215472V4
CBU216072V4

CBA213072V4
CBA213672V4
CBA214272V4
CBA214872V4
CBA215472V4
CBA216072V4

610 x 760 x 1830
610 x 910 x 1830
610 x 1070 x 1830
610 x 1220 x 1830
610 x 1380 x 1830
610 x 1530 x 1830

CBU243072V4
CBU243672V4
CBU244272V4
CBU244872V4
CBU245472V4
CBU246072V4

CBA243072V4
CBA243672V4
CBA244272V4
CBA244872V4
CBA245472V4
CBA246072V4

BASICS
SERIES

V5 5-Shelf Vented Units

2140
mm
HEIGHT

Starter units include 2 factory assembled post kits and shelves. Add on units include 1 factory assembled post kit and shelves. Units ship complete in 1 box.

Starter

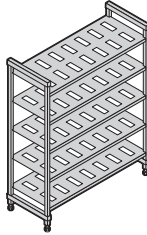

Add-On

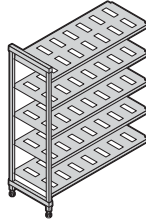

460 mm
DEPTH

DIMENSIONS D x L x H (MM)

460 x 760 x 2140
460 x 910 x 2140
460 x 1070 x 2140
460 x 1220 x 2140
460 x 1380 x 2140
460 x 1530 x 2140

CODE

CBU183084V5
CBU183684V5
CBU184284V5
CBU184884V5
CBU185484V5
CBU186084V5

CODE

CBA183084V5
CBA183684V5
CBA184284V5
CBA184884V5
CBA185484V5
CBA186084V5

540 mm
DEPTH

540 x 760 x 2140
540 x 910 x 2140
540 x 1070 x 2140
540 x 1220 x 2140
540 x 1380 x 2140
540 x 1530 x 2140

CBU213084V5
CBU213684V5
CBU214284V5
CBU214884V5
CBU215484V5
CBU216084V5

CBA213084V5
CBA213684V5
CBA214284V5
CBA214884V5
CBA215484V5
CBA216084V5

610 mm
DEPTH

610 x 760 x 2140
610 x 910 x 2140
610 x 1070 x 2140
610 x 1220 x 2140
610 x 1380 x 2140
610 x 1530 x 2140

CBU243084V5
CBU243684V5
CBU244284V5
CBU244884V5
CBU245484V5
CBU246084V5

CBA243084V5
CBA243684V5
CBA244284V5
CBA244884V5
CBA245484V5
CBA246084V5

Color: Brushed Graphite (580).

Camshelving® Basics Series Accessories

Bottom Shelf Dunnage Stands

Increase weight bearing capacity on bottom shelf only. Add to any shelf length. Highly recommended for starter units 1380 mm and longer and all corner units, intermediate units and units specified for heavier load volume on and off bottom shelves.

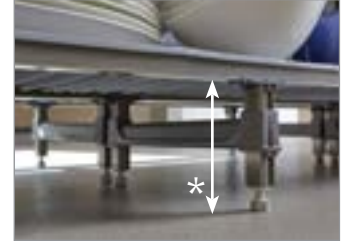

CODE	DIMENSIONS D x H* (MM)
Dunnage Stand - Low	
CBDS18H6	460 x 171
CBDS21H6	540 x 171
CBDS24H6	610 x 171

CODE	DIMENSIONS D x H* (MM)
Dunnage Stand - Tall	
CBDS18H10	460 x 273
CBDS21H10	540 x 273
CBDS24H10	610 x 273

Case Pack: 1
Color: Brushed Graphite (580).

Shelf Traverses

Available in single or double packs. Use a single set to add an open shelf for divider bars or drying racks. Add single traverses onto back posts for extra support when placing rolling equipment under the first shelf.



LENGTH (MM)	SINGLE PACK CODE*	DOUBLE PACK CODE**
760	CBTR30	—
910	CBTR36	CBTR362PK
1070	CBTR42	CBTR422PK
1220	CBTR48	CBTR482PK
1380	CBTR54	CBTR542PK
1530	CBTR60	CBTR602PK

*Case Pack: 1 **Case Pack: 2
Color: Brushed Graphite (580).

Camshelving® Basics Series Accessories

Corner Connectors

Unique patented design ensures maximum shelf space utilization. Use 1 set per shelf to connect starter and add-on units in corners. Connect 4 or 5 intermediate shelves between 2 starter units (2 sets required per shelf). Available as a single set or 8 or 10 set packs.

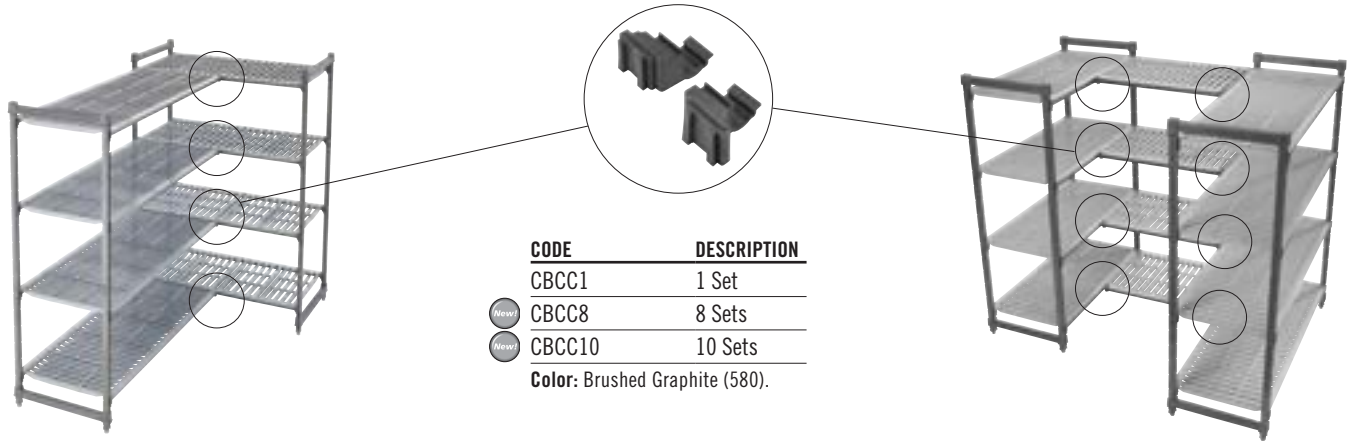

CODE	DESCRIPTION
CBCC1	1 Set
CBCC8	8 Sets
CBCC10	10 Sets

Color: Brushed Graphite (580).

Identification Tag

Clip onto shelf traverses to clearly identify stored product. Made of highly durable plastic with a clear slide in front panel. Labels included.

CODE	DESCRIPTION	SIZE (MM)
CBID6	152 mm ID Tag	25 x 152

Case Pack: 12 Color: White / Clear.



Wall Fastener

Use to secure stationary shelving unit to a wall for added safety and stability where required. Made of stainless steel. Screws not included.

CODE	DIMENSION D x L x H (MM)
CSWF	73 x 238 x 48

Case Pack: 4 Color: Silver (000).



Seismic Foot

Secure stationary unit posts directly to the floor for added safety and stability where required. Made of stainless steel. Bolts not included.

CODE	DIMENSION D x L x H (MM)
CSEQ3	102 x 83 x 59

Case Pack: 4 Color: Silver (000).



Shelf Divider

Stack and separate items stored on shelves. Made of highly durable ABS plastic. Installs directly into solid or vented shelves. Easily removeable for relocating or washing.

CODE	SIZE (MM)
CSSD188	460 X 203
CSSD218	540 X 203
CSSD248	610 X 203

Case Pack: 1 Color: Soft Grey (151).



Camshelving® Basics Series Accessories

Tray Sliding Rack (for 610 mm deep shelf only)

Holds up to 6 each full size (1826)
46 x 66 cm or 12 half size (1318)
32 x 45 cm sheet pans or trays.
Install 1 or more units onto vented
shelves, any length. High quality,
lightweight aluminum material is
safe for use in coolers and freezers.
Made from aluminum 6463
(6000 series).

CODE	DIMENSION D x L x H (MM)
CSTSR	584 x 517 x 508
Case Pack: 1 Color: Silver (000).	

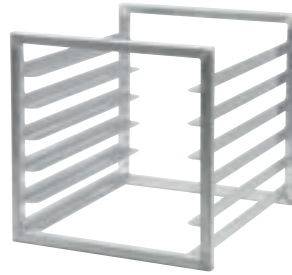

Single Shelf Security Cage (for 610 mm deep shelf only)

Securely store valuable products on
a single shelf. Made of heavy duty,
304 stainless steel for use in any
environment. Requires 457 mm height
between shelves. Install on vented
shelves only. Lock not included.

CODE	DIMENSION D x L x H (MM)
CSSC244818	640 x 1080 x 457
Case Pack: 1 Color: Silver (000).	



Vertical Drying and Storage Cradle (for 610 mm deep shelf only)

Modular 7-slot rack designed for
drying and storing trays, sheet pans,
cutting boards and lids. Installs
directly onto shelf traverses. Made of
highly durable ABS plastic. Available
in single or 3 pack.

CODE	DIMENSIONS D x L x H (MM)	CASE PACK
CSDR7	597 x 260 x 95	1
CSDR73	597 x 260 x 95	3
Color: Soft Grey (151).		



Dome Drying and Storage Cradle (for 540 mm deep shelf only)

Use to dry and safely store up to
10 patient meal delivery domes or
plate covers upright. Installs directly
onto shelf traverses. Made of highly
durable ABS plastic. Available in
single or 5 pack.

CODE	DIMENSIONS D x L x H (MM)	CASE PACK
CSDDC	520 x 415 x 86	1
CSDDC5	520 x 415 x 86	5
Color: Soft Grey (151).		

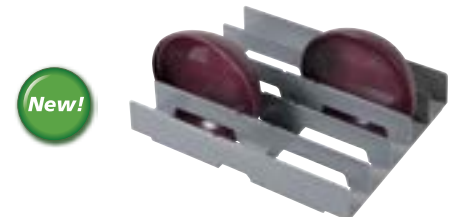

Angled Drying and Storage Cradle (for 610 mm deep shelf only)

Uniquely designed cradle holds up to
8 each meal delivery pellets or
use to dry, store and transport food
pans and other commercial kitchen
ware. Installs directly onto shelf
traverses. Made of highly durable
ABS plastic. Available in single or
4 pack.

CODE	DIMENSIONS D x L x H (MM)	CASE PACK
CSDR8	592 x 263 x 160	1
CSDR84	592 x 263 x 160	4
Color: Soft Grey (151).		



Camshelving® Wall Shelves and Shelf Extenders

Wall Shelves

- Expand storage space in kitchens, above work stations and sinks.
- Features virtually indestructible I-beam supports that hold up to 68 kg per shelf.
- Durable polypropylene withstands temperatures up to 88°C, and will not rust or corrode.
- Snap fit rail design allows shelves to snap on and off for easy cleaning.
- 5 cm backsplash and marine front edge controls spills and cross contamination.

Shelf Extenders

- Convert empty wall space into a functional storage area.
- Use with or without Camshelving Wall Shelves.
- Peg strips withstand temperatures up to 88°C, and will not rust or corrode

Wall Shelf Color: Speckled Grey (480).

Extender Peg Strip Color: Black (110).



COMPONENT



Shelf Extenders ship in one carton and include:

LENGTH	PEG STRIPS	BRACKETS	HOOKS
91 cm	3	2	6
122 cm	3	3	9



CODE	CSWS1436SK	CSWS1448SK	CSWS1436VK	CSWS1448VK
DESCRIPTION	91 cm Wall Shelf, Solid	122 cm Wall Shelf, Solid	91 cm Wall Shelf, Vented	122 cm Wall Shelf, Vented
EXTERIOR DIMENSIONS L x D x H	91 x 36 x 34 cm	122 x 36 x 34 cm	91 x 36 x 34 cm	122 x 36 x 34 cm

Case Pack: 1

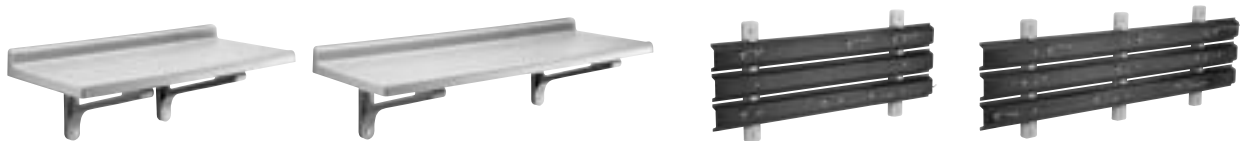

CODE	CSWS1836SK	CSWS1848SK
DESCRIPTION	91 cm Wall Shelf, Solid	122 cm Wall Shelf, Solid
EXTERIOR DIMENSIONS L x D x H	91 x 46 x 34 cm	122 x 46 x 34 cm

Case Pack: 1

CODE	CSWS36EK	CSWS48EK
DESCRIPTION	91 cm Shelf Extender	122 cm Shelf Extender
EXTERIOR DIMENSIONS L x D x H	90 x 5 x 39 cm	121 x 5 x 39 cm

Case Pack: 1

S-Series Dunnage Racks and Camlink®



S-Series Dunnage Racks

- Keep frozen, cold or dry inventory 30,5 cm safely off the floor.
- One piece construction and sturdy legs provide strength and stability.
- Heavy duty polypropylene is safe to -38°C, and will not rust, corrode or bend.
- Choose slotted tops for maximum air circulation around perishable products.
- Solid tops catch spills for easy clean up.

Colors: Dark Brown (131),
Speckled Gray (480).



CODE	EXTERIOR DIMENSIONS H x D x W	LOAD CAPACITY
Solid Top		
DRS30	30 x 53,3 x 76 cm	680 kg
DRS36	30 x 53,3 x 91,5 cm	680 kg
DRS48	30 x 53,3 x 122 cm	1,360 kg
DRS60	30 x 53,3 x 152,5 cm	1,360 kg
Slotted Top		
DRS300	30 x 53,3 x 76 cm	680 kg
DRS360	30 x 53,3 x 91,5 cm	680 kg
DRS480	30 x 53,3 x 122 cm	1,360 kg
DRS600	30 x 53,3 x 152,5 cm	1,360 kg

Case Pack: 1

Camlink

Camlink connectors securely lock dunnage racks together for greater stability.



Color: Black (110).

CODE	CASE PACK
DRLNK	6

Camlink fits all sizes and styles.
One free Camlink supplied with every Dunnage Rack.

