

# A600

## ORIGINAL OPERATING INSTRUCTIONS

Coffee machine: FCS4043 - Refrigeration unit: FCS4046



Read the operating instructions and the chapter "For your safety" before operating the machine.

Keep the Operating Instructions with the machine and pass them along to the next user if the machine is sold or transferred to a third party.



MAKE IT  
*Wonderful!*

**FRANKE**



# TABLE OF CONTENTS

FOR YOUR SAFETY . . . . .	2	MAINTAINING THE A600 . . . . .	31
PROPER USE . . . . .	2	INTRODUCTION TO THE AUTOMATIC CLEANING . . . . .	31
GENERAL SAFETY CONCERNS WHEN USING THE A600. . . . .	3	CLEANING AND MAINTENANCE PLAN . . . . .	32
EXPLANATION OF SYMBOLS . . . . .	5	STARTING THE AUTOMATIC CLEANING . . . . .	33
SYMBOLS FROM THE OPERATING INSTRUCTIONS . . . . .	5	CLEANING THE STEAM WAND. . . . .	33
SYMBOLS USED IN THE SOFTWARE . . . . .	6	RINSING THE COFFEE MACHINE . . . . .	34
DEPICTION OF ERROR MESSAGES . . . . .	7	CLEANING THE MONITOR SCREEN . . . . .	34
COLOR CODE FOR ERROR MESSAGES . . . . .	7	CLEANING THE BEAN HOPPER AND POWDER CONTAINER (WEEKLY) . . . . .	35
SCOPE OF DELIVERY AND IDENTIFICATION . . . . .	8	CLEAN THE BREWING UNIT . . . . .	36
SCOPE OF DELIVERY . . . . .	8	CLEANING THE INTERNAL WATER TANK/REPLACING THE FILTER CARTRIDGE . . . . .	36
IDENTIFICATION . . . . .	9	CLEANING THE ACCESSORIES . . . . .	36
DESCRIPTION OF THE MACHINE . . . . .	10	CONFIGURATION. . . . .	37
COFFEE MACHINE A600 . . . . .	10	INTRODUCTION TO PROGRAMMING . . . . .	37
COMPONENTS OF THE A600 . . . . .	11	"MY SETTINGS" MENU TREE . . . . .	38
FOAMMASTER COMPONENTS . . . . .	12	"CLEANING AND MAINTENANCE" MENU TREE . . . . .	38
ADD-ON UNITS . . . . .	13	MY SETTINGS . . . . .	39
THE OPERATING INTERFACE. . . . .	14	COUNTERS . . . . .	44
OVERVIEW OF OPERATING MODES. . . . .	15	INDIVIDUALIZATION AND DATA TRANSFER . . . . .	45
INSTALLATION AND TECHNICAL DATA . . . . .	17	OVERVIEW . . . . .	45
COMMISSIONING . . . . .	20	INDIVIDUALIZATION AND DATA TRANSFER . . . . .	46
INITIAL COMMISSIONING OF THE A600 . . . . .	20	INDIVIDUALIZATION AND DATA TRANSFER MENU TREE. . . . .	47
DAILY COMMISSIONING OF THE A600 . . . . .	20	REQUIREMENTS OF MY IMAGE MATERIAL. . . . .	48
FILLING AND EMPTYING . . . . .	21	NECESSARY FOLDER STRUCTURE ON THE USB STICK . . . . .	48
BEANS, POWDER AND WATER . . . . .	21	LOADING OR CLEARING MY IMAGES. . . . .	49
MILK . . . . .	24	USING MY IMAGES . . . . .	50
PREPARING DRINKS . . . . .	26	DECOMMISSIONING AND DISPOSAL . . . . .	53
PREPARING DRINKS WITH QUICK SELECT . . . . .	26	SHUT-DOWN. . . . .	53
PREPARING DRINKS WITH CASH REGISTER . . . . .	27	DISPOSAL . . . . .	54
PREPARING DRINKS WITH INSPIRE ME . . . . .	28	TROUBLESHOOTING . . . . .	55
PRODUCT WITH GROUND COFFEE -- EXAMPLE: QUICK SELECT . . . . .	29	ELIMINATING MACHINE ERRORS . . . . .	55
STEAM DISPENSER (AUTOSTEAM) -- EXAMPLE: QUICK SELECT . . . . .	30	HELP WITH PROBLEMS CONCERNING PRODUCT QUALITY . . . . .	56
		INDEX . . . . .	57
		ORIGINAL PARTS . . . . .	60

Dear Customer,

Congratulations on your purchase of an A600. Thank you for your confidence in us.

The A600 is a powerful and space-saving coffee machine that adapts to your needs perfectly. The A600 will enable you to offer high-quality coffee specialties rapidly and individually. Your customers will be impressed.

We hope you enjoy your coffee machine and that it brings you many satisfied customers.

Sincerely, Franke Kaffeemaschinen AG

# FOR YOUR SAFETY

Both you and the coffee machine are important to us. Therefore, we would like to provide you with detailed safety information. For us, a high degree of safety goes without saying. Protect yourself against residual risks arising from the functions of the machine.

## Proper use

The A600 is a coffee machine intended for use in food services, offices and similar environments. It is designed to process whole coffee beans, ground coffee, powder suitable for automatic devices and fresh milk. The A600 is intended for the commercial preparation of drinks in accordance with these instructions and the technical data.

The coffee machine is intended exclusively for operation in interior rooms.

The machine is not suitable:

- for use out of doors
- for the storage of alcoholic or explosive substances

### FoamMaster/Refrigeration unit (optional)

A FoamMaster or a refrigeration unit is used exclusively to keep milk cool while preparing coffee drinks with an A600 coffee machine. The FoamMaster is also used to generate milk foam.

Only use pre-cooled milk (2-5 °C or 36-41 °F). Only use FRANKE clean solution. Other cleaning agents may leave residues in the milk system.

### Cup warmer (optional)

The cup warmer is an optional add-on unit for your coffee machine. It is intended only for preheating coffee cups and glasses used when preparing drinks.

The cup warmer is not designed to dry dish towels or other cloths. It is not necessary to cover the cups to warm them.

### Flavor Station (optional)

The Flavor Station is intended exclusively for the automatic conveyance of syrups and other liquid aromas for the preparation of drinks. The Flavor Station is not designed to pump more viscous fluids such as chocolate sauce.

### Payment system (option)

The payment system can be used for various methods of payment, e.g. coins, card, cell etc.



Do you have any questions or problems that are not addressed in these instructions? Please do not hesitate to contact Customer Service or your service technician.

## General safety concerns when using the A600

### DANGER

#### Important

- Do not operate the coffee machine or add-on units until you have completely read and understood these instructions.
- Do not use the machine:
  - if you are not familiar with its functions.
  - if the machine or the connection lines are damaged.
  - if the machine has not been cleaned or filled as intended.
- The A600 is intended for use by trained personnel. Each operator of the A600 must have read and understood the instructions. This does not apply to its use in the self-service sector. Self-service machines must always be monitored to protect the users.
- Children under the age of 8 years are not permitted to use the machine.
- Children or persons who are challenged with respect to physical, sensory or mental abilities must not use the machine except under supervision, nor must they play with the machine.
- Children are not permitted to carry out any cleaning on the machine.
- Have the machine serviced at regular intervals. Regular maintenance will ensure the safe operation and high performance of the machine.

#### Risk of death by electrocution!

- Ensure that the power supply cable is not pinched and does not rub against sharp edges.
- Ensure that the machine and power supply cable are not near any hot surfaces such as gas or electric stoves or ovens.
- Never operate a machine that has been damaged or has a damaged power supply cable.
- If the machine power connection cable is damaged, it must be replaced by a power connection cable intended for that purpose.
  - If the power connection cable is not permanently attached, contact the service technician.
  - If the power connection cable is not permanently attached, order and use a new, original power connection cable. (See section: Original parts).
- If you suspect damage to the machine (for instance, a hot or burning odor), unplug the machine from the outlet and contact your service technician.
- Never open or attempt to repair the machine yourself. The machine contains electrically conductive parts.
- Do not make any modifications to the machine that are not described in the operating instructions.
- Have repairs on electrical parts carried out by service technicians using original spare parts.
- Have service work carried out by authorized persons only. Authorized persons can show the relevant qualification.

## **WARNING**

### Risk of injury

Reaching into the machine may result in abrasions or crushing injuries from interior components.

- Only open the machine when daily work requires it (e.g. to clean the powder system or to empty the grounds container).
- Exercise care and caution when working in an open machine.
- Only service technicians should open the machine for any other reason.

### Risk of injury, eye injury and damage to the machine

Objects in the bean hopper, powder container or grinder may splinter and be ejected, leading to damage to the machine or injury.

- Never put anything into the bean hopper, powder container or grinder.

### Danger of burns

The coffee and milk dispensers, the hot water dispenser and the steam dispenser become hot.

- Do not touch the outlets or nozzles.

The surfaces of the cup warmer are hot.

- Do not touch these surfaces.

### Risk of scalding!

During cleaning, hot water and steam are released repeatedly.

- Keep hands away from the outlets and nozzles during cleaning.

When drinks are dispensed, the products themselves pose a risk of scalding.

- Always be careful with hot drinks.

## **CAUTION**

### Danger from spoiled food residue

If the machine is not cleaned regularly, milk and coffee residue may accumulate in the machine, clog the outlets or find its way into drinks.

- Clean the coffee machine and add-on units at least once a day.
- Read the chapter "Care of the A600".

### Risk of contamination

When the machine is not in use for extended periods, residue may accumulate.

- Rinse the coffee machine before initial use and when not in use for extended periods (more than 2 days).

## **CAUTION**

### Danger of irritation with cleaning agents

Cleaning tablets and descaler can lead to irritations.

- Observe the information enclosed with the cleaning agent.
- Observe the notes on the machine during the cleaning process.
- Avoid contact with skin or eyes.
- Wash your hands before your breaks and once you have completed your tasks.

## *NOTE*

### Damage from water jets

The coffee machine is not protected against water jets.

- Avoid using water jets for cleaning and do not use high-pressure cleaners.

### Damage to the coffee machine

- Set the machine up out of the reach of children.
- Do not expose the machine to the elements, such as rain, frost or direct sunlight.

### Danger of tripping over the power supply cable

- Never let the power supply cable hang loose.

### Blockage in the powder system caused by incorrect raw materials

- Ensure that the powder and beans are poured into the correct containers. Observe the machine equipment.

# EXPLANATION OF SYMBOLS

So that you can get the most out of your A600, we would like to familiarize you with the symbols used in the Operating Instructions and software. For us, thorough information and open communication go without saying.

## Symbols from the Operating Instructions

 **DANGER** indicates potentially life-threatening danger or grave injury.

 **WARNING** indicates risk of injury.

 **CAUTION** directs your attention to a danger of minor injuries.

 **NOTE** makes you aware of the risk of damaging the machine.



Clean components with the 5-step method (see p. 31).



This symbol indicates tips, shortcuts and additional information.



Describes and illustrates an operating step that you must perform.

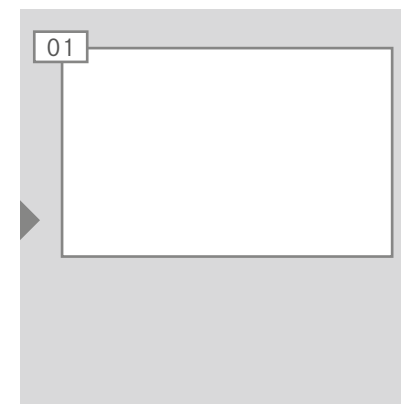











Steps on a colored background are optional. They must be performed depending on the model of your machine.





# Symbols used in the software

## Symbols on the dashboard

Symbol	Name	Description
	Franke	Call up Maintenance level
	Servicing/Cleaning	Machine must be cleaned and/or serviced
	Drip tray	Drip tray is full or not installed correctly
	Water tank	Water tank empty/missing
	Milk	Milk container is empty or not installed correctly
	Coffee bean	Bean hopper is empty or not installed correctly
	Grounds container	Grounds container must be emptied
	Rinsing	Machine must be rinsed/Machine is rinsing
	Product	
	Payment	Payment system active
	Advertising images	
	Screen saver	
	Brightness	Set brightness
	Data transfer	Data being transferred
	Individual products counter	
	Individualization	
	Info	
	Inactive	

Symbol	Name	Description
	Power button	Switch the machine to standby
	Cup heater	
	Filter	Replace the filter cartridge in the water tank
	Clean solution	FoamMaster clean solution is empty
	Favorites	Favorites key, can be assigned to an often-used function
	Service/Configuration/Administration	
	Bean left/right	
	Double product	
	Cold milk	
	Powder feed	

## Navigation

Symbol	Name	Description
	Cancel button	Cancel preparation.
	Start button	Start preparation.
	Page backwards/forwards	Scroll through menus with multiple pages.

## Depiction of error messages



Highlighted products cannot be prepared.  
The illuminated symbol on the dashboard takes you to the error message.





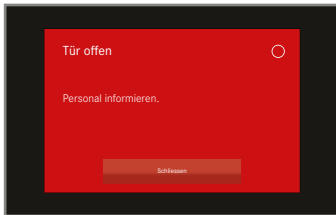

Highlighted products cannot be prepared.  
The banderole in the corner takes you to the error message.

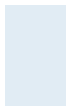

If the entire system is affected by an error, then the error message will appear automatically.

## Color code for error messages

-  Temporary interruption.
-  System still fully functional.
-  System has limited functionality.
-  Some or all resources are locked.



If a symbol is illuminated on the dashboard, tapping on the symbol will display additional information and instructions. Refer to the "Troubleshooting" chapter for help if an error occurs.

# SCOPE OF DELIVERY AND IDENTIFICATION

The A600 is a powerful coffee machine. Its modern operating concept will help you keep your cool in any situation. Listed below are ways to identify your machine and what is included in the standard delivery.













## Scope of delivery



A600 with FoamMaster



The configuration of your coffee machine may differ from that shown in the instructions. Please refer to your purchase agreement. Additional accessories may be obtained directly from your retailer or from FRANKE Kaffeemaschinen AG in Aarburg, Switzerland.

	Designation	Item no.
	Cleaning tablets (100 pcs.)	BK328400
	Clean solution Clean solution for FoamMaster	1L301219 1Z365033
	Cleaning brushes (set)	1L301376
	Screw-in brush (optional for SU05)	1B340520
	Brush, compl. (optional for FM/MS)	805610
	Cleaning brush	1L301160
	Microfiber cloth	1H325974
	Key for grind coarseness adjustment	1N330253
	Key for Neoperl jet regulator	1H327863
	USB stick (4 GB)	1H329064
	Original Operating Instructions Declaration of conformity	1C345305 1C345399
	Filter cartridge (optional for internal water tank)	
	Filter holder (optional for internal water tank)	1N330385

# Identification

## Position of type plates

A600



The type plate is located on the right next to the grounds container.

SU05



The type plate for the SU05 is located in the cooling room.

FS



The type plate for the Flavor Station is located in the interior.

CW



The type plate for the cup warmer is located on the inner side of the device at the lower left.

## Type key

### Coffee machine A600 (FCS4043)

A600	Coffee machine (fully automatic device)
MS	Milk system
FM1	FoamMaster (hot milk foam, hot and cold milk)
1G	One grinder (2G = two grinders)
1P	One powder dosing unit (2P = two powder dosing units)
H1	Hot water
S1	Steam wand
S2	Autosteam
S3	Autosteam Pro
W1	Fixed water connection
W2	Water tank

### Add-on units

SU05	Refrigeration unit (< 10 l)
MS1	Milk system without pump in SU05
MS2	Milk system with pump in SU05
FM1	FoamMaster (cold and hot milk, cold and hot milk foam)
1C1M	1 coffee machine, 1 milk type
CW	Cup warmer
AC	Payment device

# DESCRIPTION OF MACHINE

Congratulations on selecting the A600 for the single-serve coffee experience you have been waiting for. Here you will get to know the components of your coffee machine and learn more about its functions and options.

## Coffee machine A600

### Introduction

The A600 coffee machine has numerous options. To give you an overview of your coffee machine, a sample configuration is illustrated below.

Please note that your coffee machine may look different from the configuration shown here.



# Components of the A600

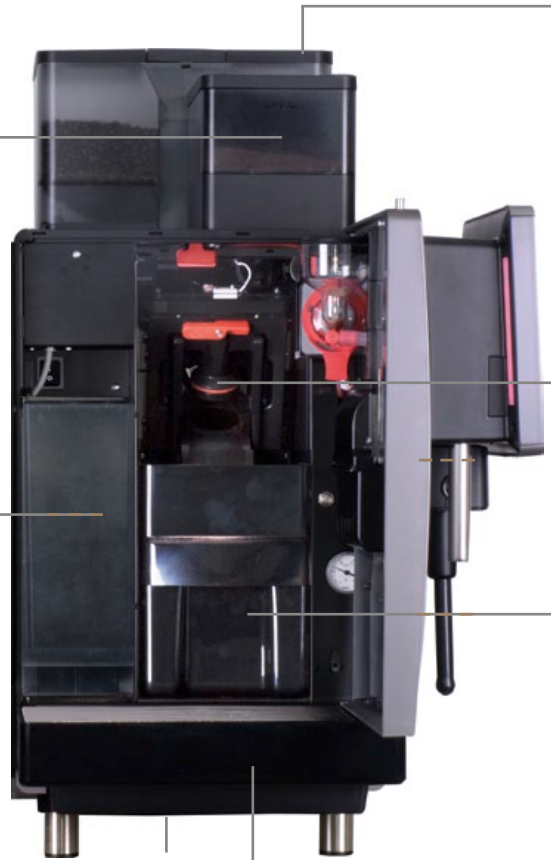
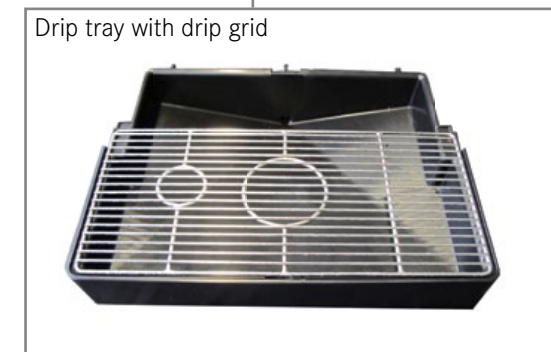

# FoamMaster components



Temperature display

Main switch



## Add-on units

The coffee machine can be extended by add-on units.  
Please note the permitted machine combinations and the operating instructions of the add-on units.



### FoamMaster (option)

The FoamMaster provides tasty milk foam beverages. It keeps the milk fresh, heats it up and turns it into foam as needed. The FoamMaster forms a unit together with your A600.



### Refrigeration unit SU05 (optional)

You can connect the refrigeration unit directly to the A600 to make sure the milk for your coffee beverages stays fresh.

Additional refrigeration units available for the A600:

- UT05
- SU12/UT12
- KE200
- UKE
- Chill&Cup



### Flavor Station (optional)

Our Flavor Station is available to you as an option for unusual creations. You can use the Flavor Station to extend your offerings with up to three different flavors.



### Cup warmer (optional)

To enjoy coffee at its best, you need pre-heated cups. The cup warmer fits perfectly on your A600.

### Payment system (option)

For recording payment data.



# The operating interface

Menu elements of the operating interface, using Quick Select as an example

The FRANKE button is used to switch between Maintenance level and Product level.



Scroll forwards/backwards.

## Navigation



To select an option, tap on the respective field.



For scrolling, press the arrow keys on the right-hand and left-hand sides of the screen.

## Switching to Energy saver mode



Switch to Maintenance level.



Select Standby button and confirm.



To finish Energy saver mode, tap on the operating interface.

# Overview of operating modes

## Cash Register

Non-self-service



Cash Register is the operating mode for non-self-service utilization.

While your coffee machine is preparing a product, you can already add additional orders.

Structure of the operating interface:

- Level 1: Product selection. Column with the possible options, the production status and the waiting list

Individual adaptations:

- Display: 2x2, 3x3 or 4x4 products per page

## Quick Select

(optional with Credit Mode)

Self-service



The Quick Select operating mode is the standard setting for self-service.

Once your customer has selected a drink, he can adapt it in the second step if product options are activated.

Structure of the operating interface:

- Level 1: Product selection
- Level 2: Drink Selection status, select product options, start preparation (if activated)

Individual adaptations:

- Display: 2x3, 3x4 or 4x5 products per page
- Activate Credit Mode

## Inspire Me

Self-service



The Inspire Me operating mode is particularly suitable for self-service.

It inspires your customers to find the perfect drink for themselves.

Structure of the operating interface:

- Level 1: Menu cards with prefiltered selection
- Level 2: Product selection
- Level 3: Drink Selection status



The suitable operation mode is dependent on the utilization of your coffee machine, your product range and the preferences of your customers. Your Service technician will be happy to help you set the appropriate operating mode.

### Cash Register



Product selection

### Quick Select



Product selection

### Inspire Me



Menu cards

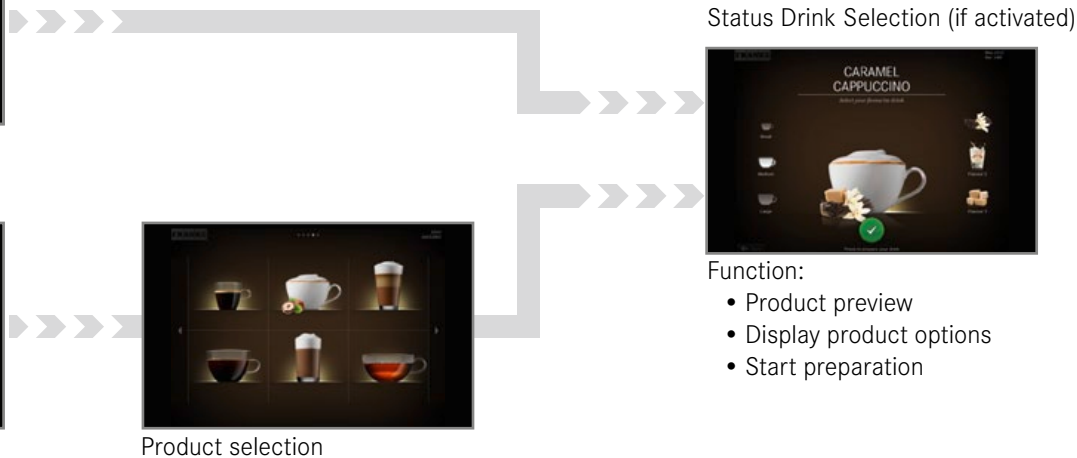

### Status Drink Selection (if activated)



#### Function:

- Product preview
- Display product options
- Start preparation

## Credit Mode in the Quick Select operating mode



#### Display:

- Product prices
- Credit
- Missing credit



- In the Drink Selection status, you cannot add any drink options with the Credit Mode configuration.
- You can activate Credit Mode in the My Settings menu under 1 Set Machine, 1.5 Payment. Select Activate payment.

# INSTALLATION AND TECHNICAL DATA

Your A600 must be properly installed so that you can operate it correctly – your service technician will gladly do that for you. You'll have to take care of a few things first. You'll find the requirements for problem-free enjoyment of your coffee machine here.

## Preparations

- The power connection for the coffee machine must be protected by a ground fault circuit interrupter (FI).
- Each terminal of the power supply must be able to be interrupted by a switch.
- The fixed water connection must have a water shut-off with a check valve and filter that can be inspected and must meet the requirements of the technical data.
- The fixed water connection to your coffee machine must be done using the hose set that is supplied with it. Do not use any other water hoses that happen to be present.

## Installation

You must have completed these preparations before one of our Service technicians can install the coffee machine for you. Your Service technician will install your coffee machine and carry out the initial commissioning. The technician will walk you through the basic functions.

## Capacities in accordance with DIN 18873-2

Specialty	Hourly capacity Cups/h (double dispensing)
Espresso	150 (194)
Café crème	100 (121)
Cappuccino	98 (160)
Hot water (200 ml)	164

## A600 technical data (FCS4043)

Bean hopper	2 kg with one grinder	2 x 1.2 kg with two grinders
Powder container	1.2 kg (may differ from this, depending on the powder used)	
Grounds container	60 - 110 cakes, depending on the grind quantity (optional: coffee ground chute)	
Boiler for coffee	0.9 l; operating pressure 800 kPa (8 bar); 230 V; 2.5 kW (1.8 kW with 10 A fuse)	
Boiler for hot water/steam	0.9 l; operating pressure 100 kPa (2.1 bar); 230 V; 2.5 kW (1.8 kW with 10 A fuse)	
Electrical connection (see type plate)	EU	220 - 240 V/50 - 60 Hz 1L N PE 2.4 kW - 2.8 kW Fuse: 16 A (locked) 220 - 240 V/50 Hz 1L N PE 2.1 kW - 2.3 kW Fuse: 10 A (locked)
	USA	200 - 220 V/60 Hz 2L PE 4.5 kW - 5.3 kW Fuse: 30 A (locked)
	Japan	200 V/50 - 60 Hz 2L PE 2.0 kW Fuse: 16 A (locked)
	China	220 V/50 Hz 1L N PE 2.4 kW Fuse: 16 A (locked)
Noise emission	< 70 dB	
Weight	Approx. 38 kg	
Fixed water connection	G 3/8" outside thread	
Water pipeline pressure	80 - 800 kPa (0.8 - 8.0 bar)	
Water shut-off	With check valve and filter	
Water tank	Internal/External (optional)	
Wastewater tank	Internal/External (optional)	
Water hardness	Max. 70 mg CaO/l water (7dH, 13 °fH)	
Ideal pH value	7	
Funnel	d = 50 mm (2") with siphon	
Drain pipe	dmin = 1"	
Ambient conditions	Humidity: max. 80% Ambient temperature: 10 - 32 °C	

## Dimensions of the A600 FoamMaster

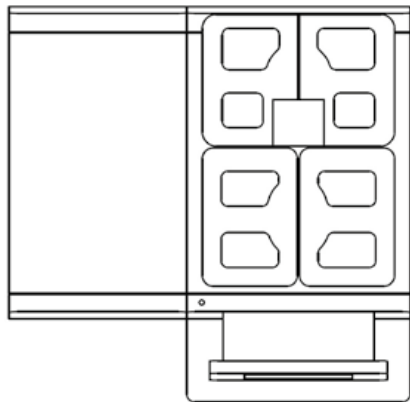
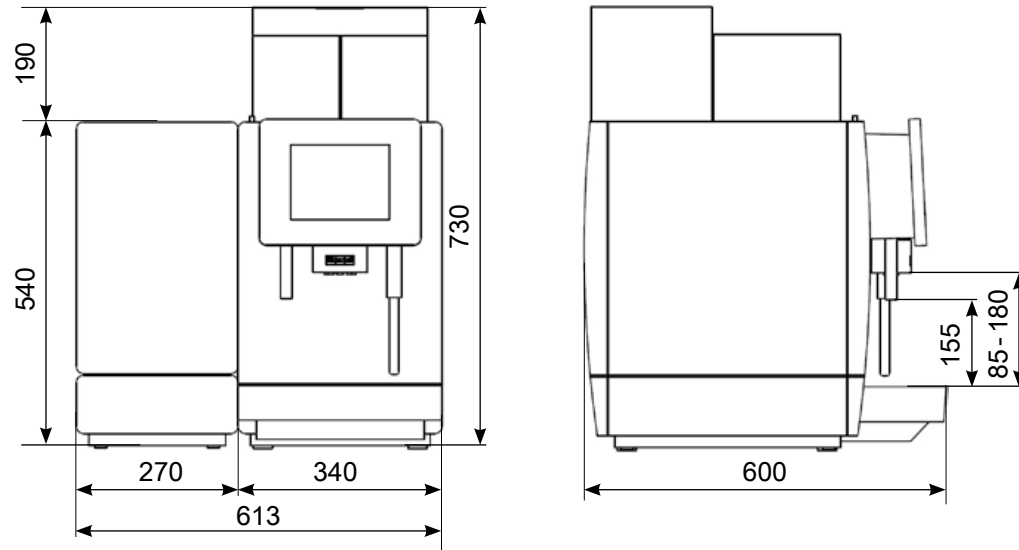

## Adjustable feet

	Total height
40 mm (standard)	730 mm + 40 mm = 770 mm
100 mm (optional)	730 mm + 100 mm = 830 mm

## Installation dimensions of the A600

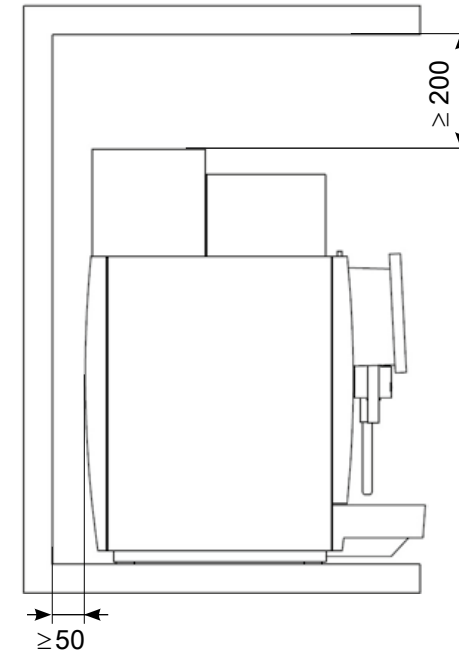

The dimensions are specified in mm.

Prepare a stable, ergonomic surface (min. load capacity: 150 kg or 330.7 lb). The operator panel should be at eye level.

Minimum clearances:

- To the rear wall: 50 mm
- Upwards: 200 mm (filling and removal of coffee bean hopper)

Adjustable feet (optional) can be used to compensate for unevenness or height differences.

## FoamMaster SU05 FM (option) / SU05 MS (option)

Device type	FCS4048	
Milk container	5 l	
Electrical connection	EU	220 – 240 V 1LNPE 50/60 Hz
		SU05 FM 1.95 – 2.3 kW
		SU05 MS Current consumption: 0.72 A
	USA	120 V 1LNPE 60 Hz
		SU05 FM 1.44 kW
	SU05 MS Current consumption: 1.5 A	
Electric cable	1800 mm	
Ambient conditions	Humidity: max. 80%	
	Ambient temperature: 10 – 32 °C	
Coolant	R134a / 40 g	
Climate class	N (temperate climate)	
Noise emission	< 70 dB(A)	
Cooling temperature	2.0–5.0 °C	
Empty weight	SU05 MS 16.1 kg (with base 17.6 kg)	
	SU05 FM 23.0 kg (with base 24.5 kg)	
Width/Depth/Height	270 mm/474 mm/540 mm	

## Cup warmer CW (optional)

Device type	FCS4054
Capacity	Up to 120 cups (depending on cup size)
Electrical connection	220 – 240 V 1LNPE 120 W 50/60 Hz Fuse: 10 A
Weight	Approx. 20 kg
Width/Depth/Height	270 mm/475 mm/540 mm

## Payment system AC (option)

Device type	FCS4056
Electrical connection	85–264 V 1LNPE
Weight	Approx. 18 kg
Wastewater tank/Drip tray	3 l
Width/Depth/Height	200 mm/451 mm/542 mm

## Flavor Station FS30 (option)

Device type	FCS4055
Capacity	Up to 3 varieties of syrup
Electrical connection	220–240 V 1LNPE 75 W 50/60 Hz Fuse: 10 A
Electric cable	1800 mm
Weight	Approx. 17 kg
Width/Depth/Height	200 mm/451 mm/545 mm

## Refrigeration unit KE200 (optional)

Weight	Approx. 13 kg
Width/Depth/Height	225 mm/453 mm/330 mm

## Chill & Cup (optional)

Weight	Approx. 29 kg
Width/Depth/Height	334 mm/471 mm/502 mm

## Base refrigeration unit UAE (optional)

Weight	Approx. 27 kg
Width/Depth/Height	320 mm/646 mm/238 mm

## SU12/UT12 (optional)

Weight	Approx. 26 kg
Width/Depth/Height	340 mm/475 mm/540 mm

## Water tank/Wastewater tank (option)

Water tank (internal)	4 l
Water tank (external)	14 l
Wastewater tank/Drip tray	3 l
Wastewater tank (external)	14 l

# COMMISSIONING

In this chapter you will learn how to start up your A600 coffee machine for the first time.

## Initial commissioning of the A600



Your service technician will put your coffee machine in operation for the first time and show you how to operate it. Later recommissioning will also be made by your service technician.

## Daily commissioning of the A600

### **WARNING**

#### Risk of scalding!

The machine releases hot water and hot steam.

- Do not touch the outlets or the area beneath them.

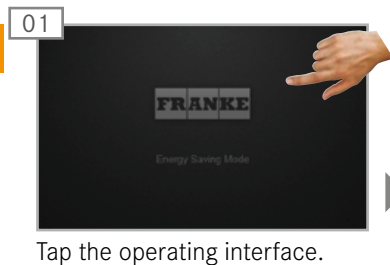

If necessary, add coffee beans, suitable powder for automatic machines, milk and syrup. Also fill up the machine with water for operation with the water tank.

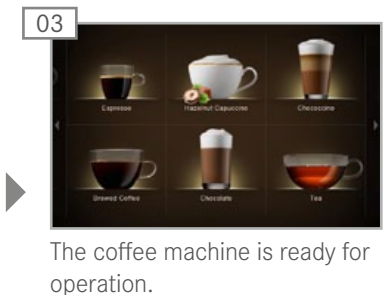

# FILLING AND EMPTYING

Ensure that all ingredients are always available. That way you will be able to offer your customers the wide assortment of your product range at all times. Be prepared for a successful day.

## Beans, powder and water

### Filling the coffee bean hopper and powder container

#### **WARNING**

Risk of injury, eye injury and damage to the machine

If objects find their way into the bean hopper or grinder, splinters may be ejected, leading to injuries or damage to the machine.

- Never put any objects in the coffee bean hopper or grinder.



Fill the bean hopper with coffee beans.  
Fill the powder container with powder suitable for automatic coffee makers.

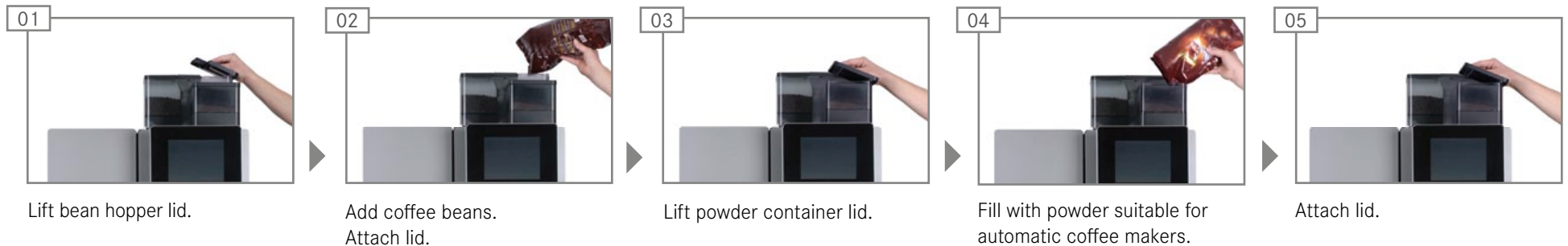



## Filling the water tank (optional)



01 Pull out the water tank.  
Remove the lid.



02 Fill water tank up to marking  
with fresh water.  
The surface of the sensor must  
be dry.



Information on inserting and  
replacing the water filter can be  
found in the chapter  
"Care of the A600", p. 36.



03 Attach lid.  
Slide water tank in.

### NOTE

#### Machine damage

Incorrect filling of the machine causes  
damage to the machine.

- Fill the water tank with water only.
- If there is milk in the Fluid-System.
- Disconnect the machine from the power supply.
  - Call Service.

## Emptying the bean hopper, setting the grind coarseness



01 Pull the locking slide towards  
the front up to the stop.



02 Remove bean hopper upwards.  
Empty, clean and dry the bean  
hopper.



For notes on cleaning the bean  
hopper, see Chapter "Care of  
the A600", p. 35.



If needed, the grind coarseness  
can be set in stages for each  
grinder.



03 Set the grind coarseness with  
the grinder adjustment wrench.

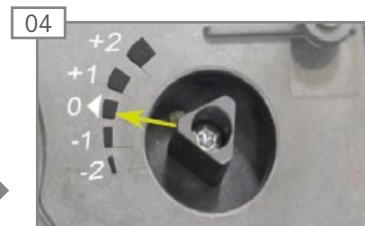

04 +2 => very coarse  
0 => normal  
-2 => very fine

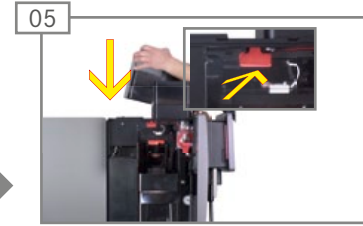

05 Attach the bean hopper.  
Push the locking slide up to the stop.

### NOTE

#### Impairment of function

If the bean hopper and powder container are not locked correctly, this may  
impair both the function of the coffee machine and the product quality.

- Push the locking slide all the way in.

## Empty powder container

### NOTE

#### Soiling

Powder may escape.

- Always transport the powder container in an upright position and closed.



01 Pull the locking slide towards the front up to the stop.

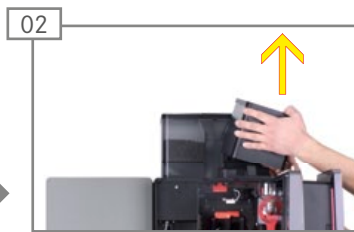

02 Remove the powder container upwards. Empty the powder container.

### CAUTION

#### Cutting injuries/crushing

The powder container's conveyor mechanism can cause cuts or crushing injuries.

- Exercise care when cleaning the powder container.



For notes on cleaning, see Chapter "Care of the A600", p. 35.

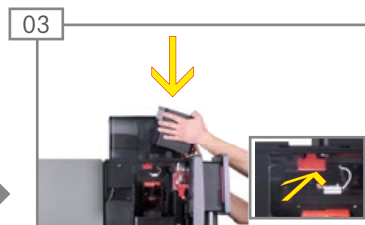

03 Attach the powder container. Pull the locking slide all the way to the rear.

### NOTE

#### Impairment of function

If the bean hopper and powder container are not locked correctly, this may impair both the function of the coffee machine and the product quality.

- Push the locking slide all the way to the rear.

## Emptying the grounds container

### NOTE

#### Formation of mildew

Coffee residue can lead to mildew formation.

- Empty and clean the grounds container at least once daily.



01 Open the door and remove the grounds container.

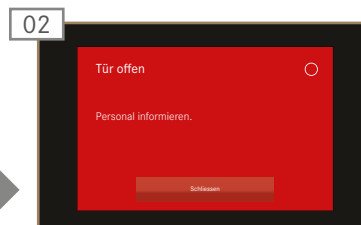

02 The message DOOR OPEN appears on the operating interface.

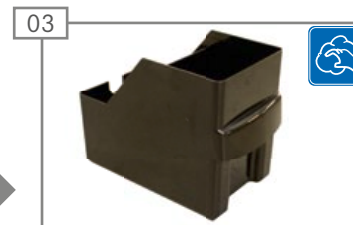

03 Empty, clean and dry the grounds container.

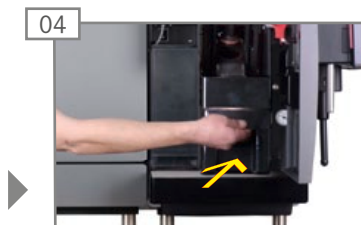

04 Insert the grounds container and close the door.

# Milk

## Filling the refrigeration unit (optional)

### NOTE

#### Drink quality

Incorrect handling of milk can lead to quality problems.

- Only clean containers should be filled with milk.
- Only use pre-cooled milk (2 - 5 °C or 36 - 41 °F).
- Only touch the intake hose, the inside of the milk container and the milk lid after sanitizing your hands, or wear disposable gloves.
- Place the container lid with the suction hose only on a surface that is clean.



01 Open the door and switch on the refrigeration unit.



02 The current cooling chamber temperature is displayed.



03 Remove the milk container.

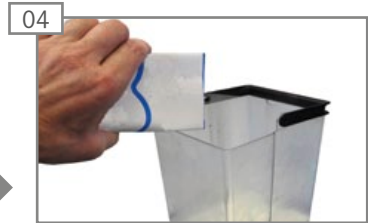

04 Remove the milk container lid. Fill the milk container with a maximum of 5 liters of cooled milk.



05 Attach the milk container lid.



06 Slide the milk container all the way in.



07 Close the door.

For notes on cleaning the milk system, see Chapter "Care of the A600", p. 33.

## Preparing the milk system



The milk system is prepared semi-automatically after a cleaning or a filling procedure.

Please observe the instructions in the event messages.

Access to the event messages is through the dashboard and requires no login.

## Emptying the refrigeration unit

### NOTE

#### Milk quality

The refrigeration unit is intended solely for keeping the milk cool during use.

- Remove the milk and store it in a refrigerator when the coffee is not going to be used for a prolonged time, e.g. overnight.



### CAUTION

#### Health risks due to spoiled milk

Milk residue could build up in the machine as the result of insufficient cleaning. This residue could clog outlets or make its way into the products.

- Clean the refrigeration unit and the milk system at least once a day using the automatic cleaning program.

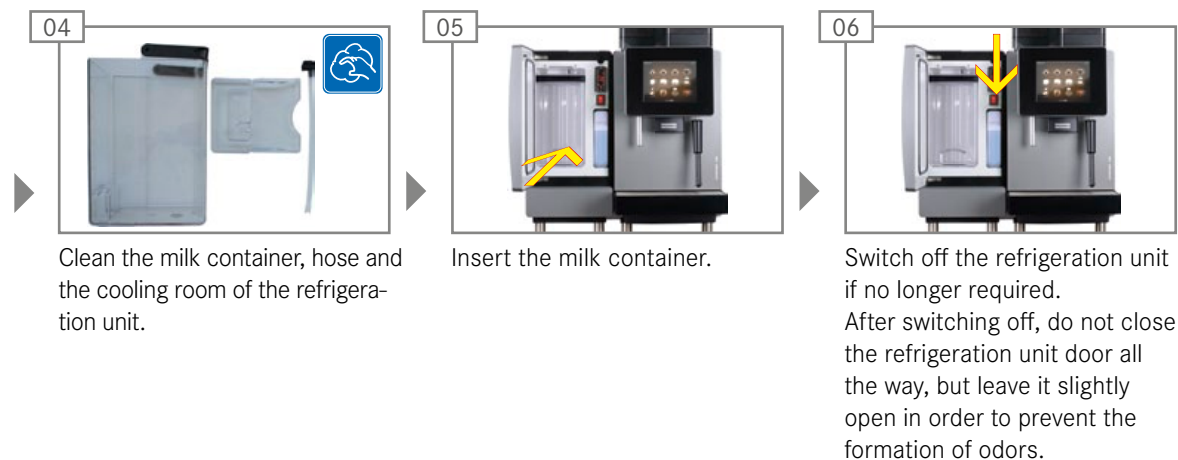

# PREPARING DRINKS

You chose the A600 because you love coffee and want to offer your customers something special. In this section you will find information about preparing drinks and the possible variations for your specialty drinks.

## Preparing drinks with Quick Select



Place the appropriate cup or glass under the outlet.

### **WARNING**

**Risk of scalding or burning!**

The dispensers and drinks are hot.

- Do not touch the area under the outlets.
- In case of scalding or burns, immediately cool the affected area and consult a doctor depending on the severity of the injury.



Select product.



The Drink Selection product preview appears. Select product options.



Start preparation with the green button.



The outlet lowers. Preparation begins.



Product selection appears. Product is ready.

# Preparing drinks with Cash Register



When you prepare several products one after the other, be sure to observe the following:

- Have sufficient glasses or cups ready to use.
- You can continuously add new products to the waiting list during the preparation.
- You can select and clear products from the waiting list.



01 Place an appropriate cup or glass under the outlet.

## WARNING

**Risk of scalding or burning!**

The dispensers and drinks are hot.

- Do not touch the area under the outlets.
- In case of scalding or burns, immediately cool the affected area and consult a doctor depending on the severity of the injury.



02 Select product options.



03 Select product. Preparation begins.



04 Add more products to the waiting list as needed.



05 Start preparation of each of the products in the waiting list by pressing the green button.



06 The outlet lowers. Next preparation begins.



07 Product selection appears. All products are ready.

# Preparing drinks with Inspire Me



01 Place an appropriate cup or glass under the outlet.

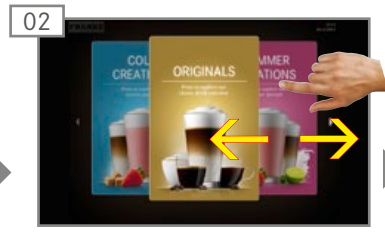

02 Scroll through the menu cards.



03 Tap on the desired menu card with your finger. The drinks overview appears.

## **WARNING**

**Risk of scalding or burning!**

The dispensers and drinks are hot.

- Do not touch the area under the outlets.
- In case of scalding or burns, immediately cool the affected area and consult a doctor depending on the severity of the injury.



04 Select product.



05 The Drink Selection product preview appears. Select product options.



06 Start preparation with the green button.



07 The outlet lowers. Preparation begins.



08 Menu cards appear. The drink is ready.

# Preparing drink with ground coffee

## Example: Quick Select



- Only ground coffee - decaffeinated or with caffeine - can be used.
- Soluble instant coffee made from dried coffee extract cannot be used.



01 Place an appropriate cup or glass under the outlet.

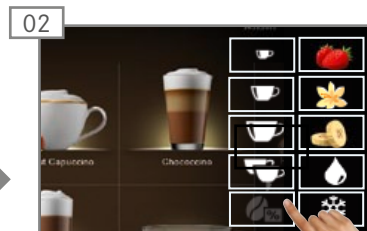

02 Press the Decaffeinated coffee selection key.

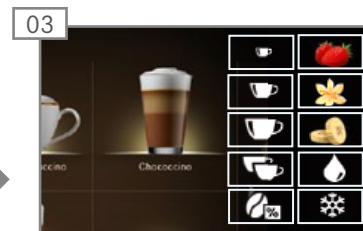

03 The Decaffeinated coffee selection key lights.

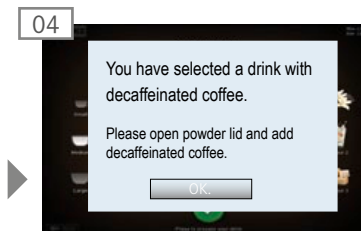

04 Message: Open powder lid and add decaffeinated coffee.



05 Open the powder lid.



06 Add powder.  
Close the powder lid.

### WARNING

#### Risk of scalding or burning!

The dispensers and drinks are hot.

- Do not touch the area under the outlets.
- In case of scalding or burns, immediately cool the affected area and consult a doctor depending on the severity of the injury.

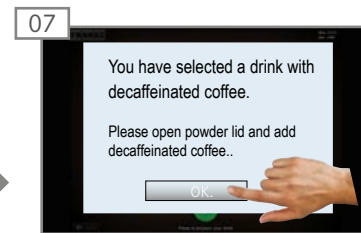

07 Confirm with OK.



08 The outlet lowers.  
Preparation begins.

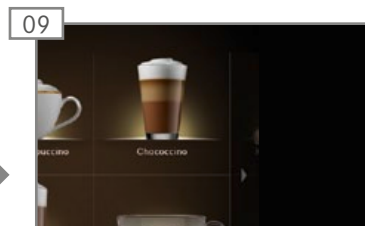

09 Product overview appears.  
Product is ready.



# Steam dispenser (Autosteam/Autosteam Pro)

## Example: Quick Select



Autosteam is suitable for the manual heating and foaming of milk and for the heating of other drinks.



01 Hold a suitable container under the steam outlet.

### **WARNING**

#### Risk of scalding or burning!

The dispensers and drinks are hot.

- Do not touch the area under the outlets.
- In case of scalding or burns, immediately cool the affected area and consult a doctor depending on the severity of the injury.



02 Select the steam dispenser.  
The steam output starts immediately.

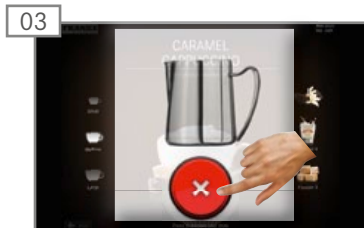

Depending on the model of the steam wand, the steam dispenser is automatically ended when your drink has reached the specified temperature (Autosteam/Autosteam Pro) or the steam dispenser cycle has ended (steam wand).

Independent of this, the steam output can be ended at any time by pressing the cancel button.



04 The drink has reached the specified temperature.  
The drinks overview appears.



05 After each use:

- Wipe the steam outlet with a damp cloth.
- Start the steam dispenser briefly to clean the nozzle.

# CARE OF THE A600

Even a coffee machine like the A600 must be cared for. To ensure high-quality flavor, the A600 must be cleaned at least once a day and serviced at regular intervals.

## Introduction to automatic cleaning



Your responsibility for the perfect coffee experience.

The perfect coffee experience depends on a perfectly cleaned coffee machine.

Increase the quality of your products!

Clean your coffee machine at least once a day and more frequently if necessary.

Follow the 5-step method for all removable parts.

Accessories required:

- Cleaning tablets
- Microfiber cloth
- Brush set
- Cleaning container
- Clean solution



### 5-step method for removable parts



## Cleaning and maintenance plan

Frequency	Task	Information
Daily	Clean the A600	See p. 33
	Clean the steam wand	See p. 33
	Clean the interior, the inside of the door and the door seal in the refrigeration unit	See p. 36
	Clean the internal water tank	See p. 36
	Clean the external water tank/wastewater tank and connecting lines	See p. 36
	Clean the milk hose and suction filter of the milk container	See p. 36
Weekly	Clean the coffee bean hopper	See p. 35, Image 1-5
	Clean the powder container	See p. 35, Image 6-9
	Clean the brewing unit	See p. 35, Image 10
If needed/prompted	Rinse the A600	See p. 34
	Descale the jet regulator for hot water	See p. 36, Image 14
	Replace the water filter in the water tank	See p. 36, Image 7, 9
Annually or after every 40,000 drinks	Maintenance by service technician	Contact a service technician

## Starting the automatic cleaning



Switch to Maintenance level.  
Authenticate with the PIN code if necessary.



The factory-set PIN code is 1111.

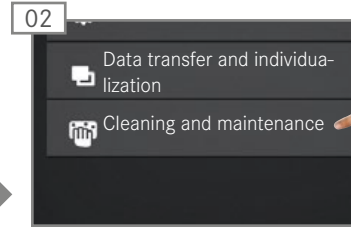

Select Cleaning and maintenance.



**Danger of scalding.**  
During cleaning, hot water and steam are released repeatedly.  
• Do not touch the outlets or the area beneath them.

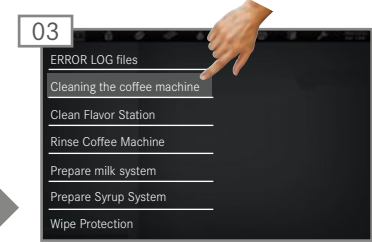

Select Clean Coffee Machine or Clean Flavor Station and confirm.

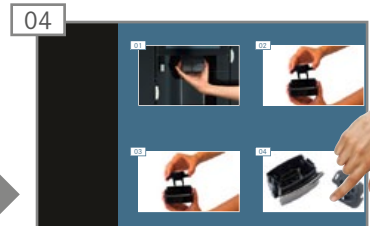

Follow the instructions on the operating interface and confirm with Continue.

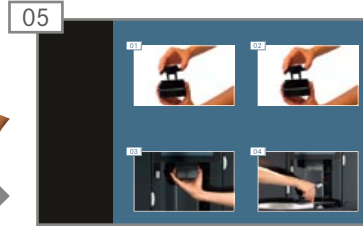

The machine guides you to the next step.



After the cleaning cycle, the machine switches back to either the maintenance level or to the energy saver mode.  
Your Service technician can set the desired option for you.

## Clean the steam wand



Fill container to approx. 5 cm with cold water and 30 ml of clean solution.  
Place under the steam wand for approx. 1 minute.



Select Autosteam/Steam.  
The steam wand is being cleaned.



Empty the container.  
Fill the container with cold water and place under the steam wand.



Select Autosteam/Steam.  
The steam wand is being rinsed.



Empty the container  
Wipe the steam wand with a cloth.

# Rinse Coffee Machine



- Rinsing is not a substitute for daily cleaning. Rinsing is necessary to remove residue build-up in the coffee and milk systems.
- The A600 automatically rinses after certain time intervals as well as when it is switched on or off.



01 Switch to Maintenance level.

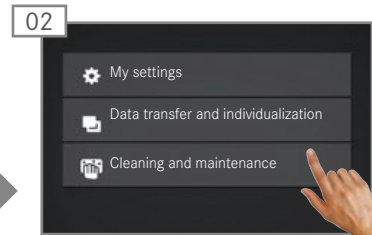

02 Select Cleaning and maintenance.

## WARNING

Danger of scalding.  
Hot water is released during rinsing.

- Do not touch the outlets or the area beneath them.
- Do not place anything on the drip grid.

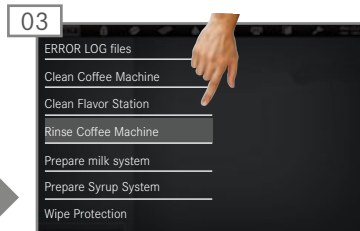

03 Select Rinse Coffee Machine and confirm.  
A600 is being rinsed.

# Cleaning the monitor screen



01 Switch to Maintenance level.

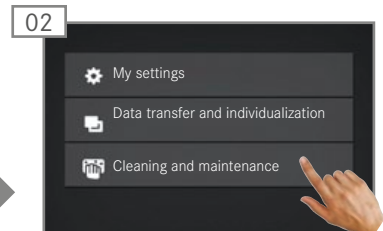

02 Select Cleaning and maintenance.



You cannot cancel the locking of the operating interface. Locking lasts 20 seconds.

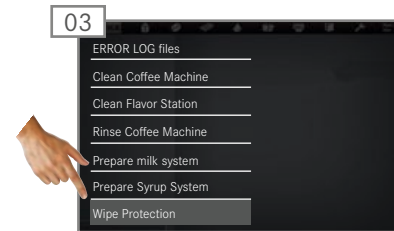

03 Select Wipe Protection.  
The operating interface is locked for 20 seconds.

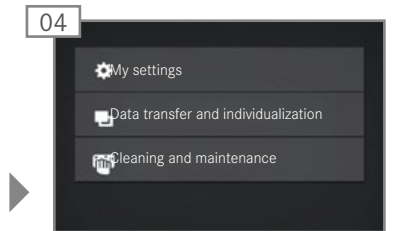

04 Clean the monitor screen.  
Maintenance level appears.

# Cleaning the bean hopper and powder container (weekly)



01 Open the door.



02 Pull the locking slide all the way to the front.



03 Lift up the bean hopper. Empty the bean hopper.

## NOTE

Soiling, formation of mildew

The bean hopper dries slowly and can continue to release moisture during fitting.

- Do not bring the bean hopper into direct contact with water.
- Only use a damp cloth for cleaning.
- Remove detergent residue.



04 Rub out the bean hopper with a dry cloth.



05 Attach the bean hopper.



06 Lift the powder container up. Empty the powder container.



07 Clean the powder container with a cloth. Use detergent if necessary. Rub out the powder container with a dry cloth.

## CAUTION

Cutting injuries/crushing

The powder container's conveyor mechanism can cause cuts or crushing injuries.

- Exercise care when cleaning the powder container.



08 Clean the powder chute with a brush.



09 Attach the powder container.



10 Push the locking slide all the way to the rear.

## NOTE

Impairment of function

If the bean hopper and powder container are not locked correctly, this may impair both the function of the coffee machine and the product quality.

- Push the locking slide all the way to the rear.



11 Close the door.

## Cleaning the brewing unit



01 Open the door.



02 Release the brewing unit lock in counterclockwise direction.



03 Remove the brewing unit.

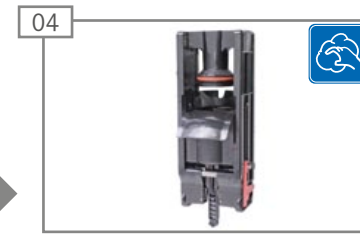

04 Clean the brewing unit.

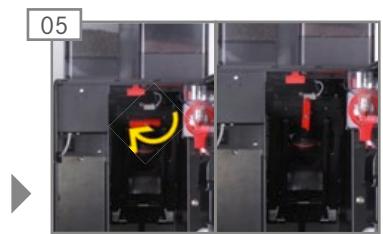

05 Insert the brewing unit. Lock in clockwise direction.

## Cleaning the internal water tank/Replacing the filter cartridge



06 Pull out the water tank. Remove the lid.



07 Turn the filter cartridge (optional) counterclockwise and remove.



08 Clean the water tank using the 5-step method.



09 Fill the new filter cartridge with water. Insert the filter cartridge in the filter holder and turn clockwise until it hits the stop.



10 Close the water tank with the lid and push into the machine.

## Cleaning the accessories

### NOTE

Impairment of function  
Soiled accessories can have a negative affect on the function and quality of the drinks.

- Clean the accessories using the 5-step method.
- Follow these instructions for accessories.



11 Clean the refrigeration unit and its connecting lines.

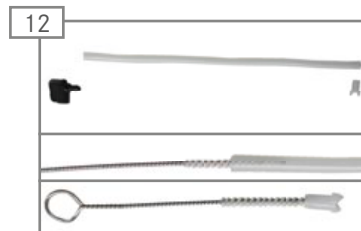

12 Remove the milk hose. Clean the hose with the brush. Clean the suction filter with screw-in brush.

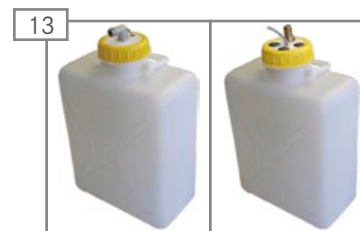

13 Clean the water tank/wastewater tank and connecting lines.



14 Remove the jet regulator for hot water with the tool and descale.

# CONFIGURING

Your A600 can be programmed individually – so that the coffee machine is just as flexible as you are. We have kept the programming simple to make your job easier. Try it for yourself.

## Introduction to programming



- All programming menu items are shown on the following pages. Some of these menu items may not be featured on your A600, depending on the configuration.
- Default PIN codes are assigned from the factory:

	Owner	Specialist	Operator
Default PIN	1111	2222	7777
My PIN			

- The PIN codes for key (secured) products and On/Off Machine can be viewed and changed with the owner role in the My Settings/Access rights menu.

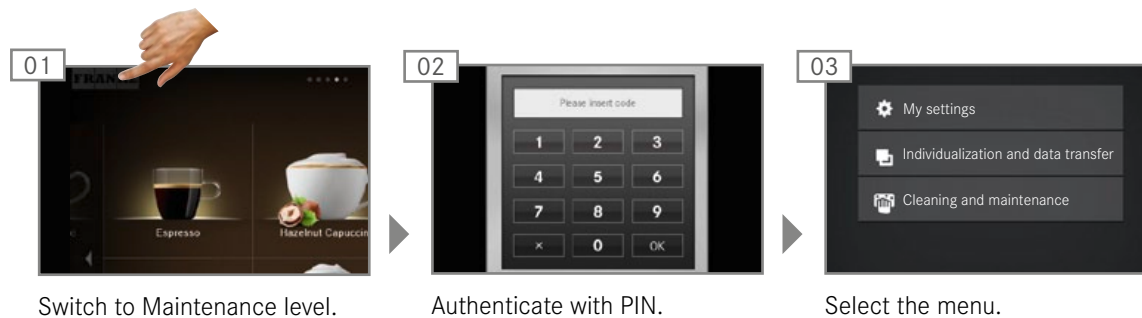

Confirm each of the changes with Save.



# "My Settings" menu tree

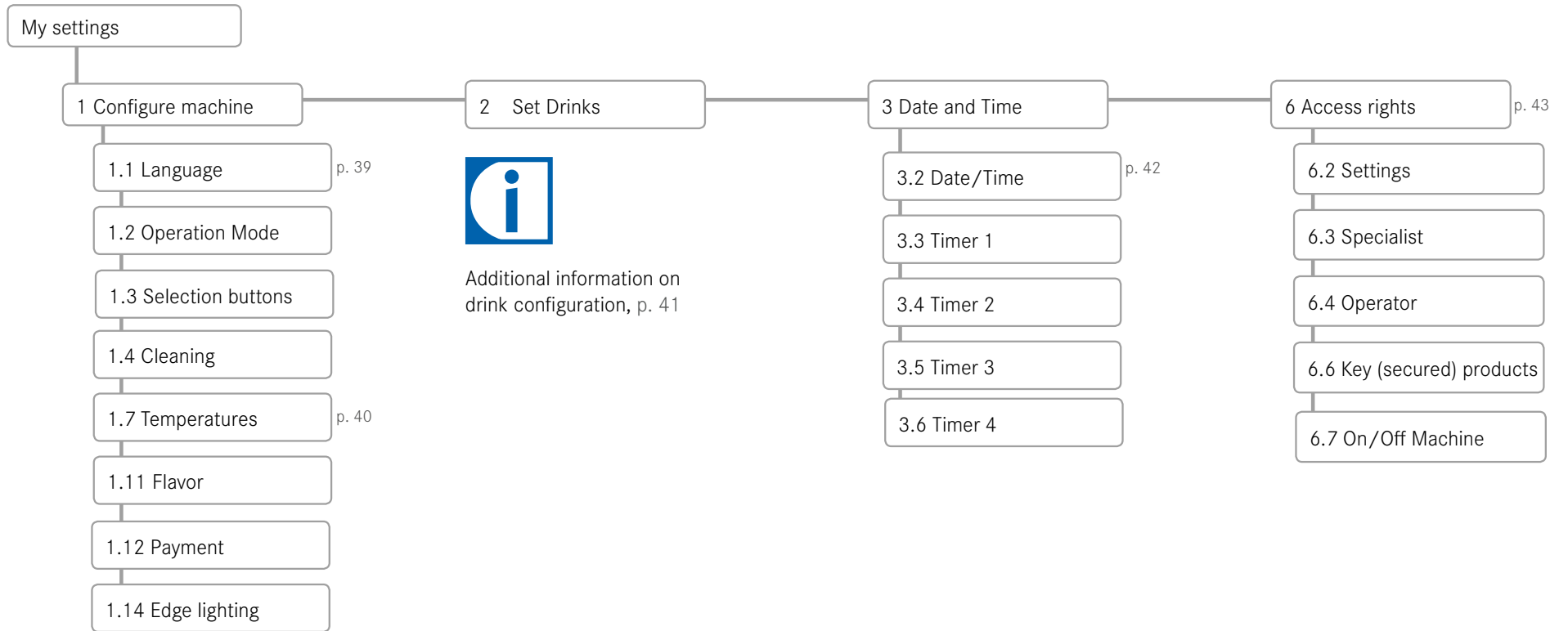

# "Cleaning and maintenance" menu tree



# My Settings

## 1 Set Machine

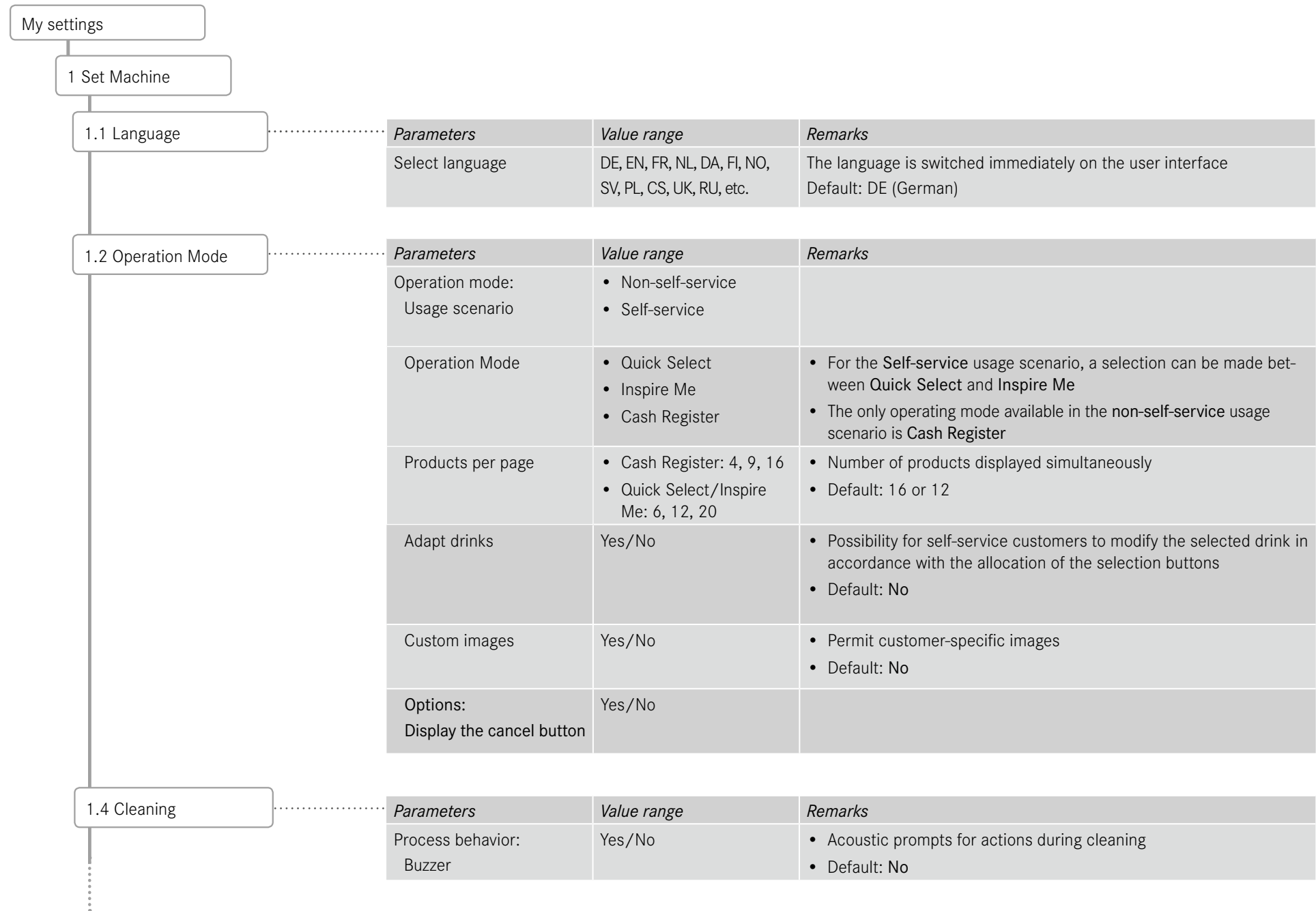

My settings

1 Set Machine

1.1 Language

Parameters	Value range	Remarks
Select language	DE, EN, FR, NL, DA, FI, NO, SV, PL, CS, UK, RU, etc.	The language is switched immediately on the user interface Default: DE (German)

1.2 Operation Mode

Parameters	Value range	Remarks
Operation mode: Usage scenario	<ul style="list-style-type: none"> <li>Non-self-service</li> <li>Self-service</li> </ul>	
Operation Mode	<ul style="list-style-type: none"> <li>Quick Select</li> <li>Inspire Me</li> <li>Cash Register</li> </ul>	<ul style="list-style-type: none"> <li>For the <b>Self-service</b> usage scenario, a selection can be made between <b>Quick Select</b> and <b>Inspire Me</b></li> <li>The only operating mode available in the <b>non-self-service</b> usage scenario is <b>Cash Register</b></li> </ul>
Products per page	<ul style="list-style-type: none"> <li>Cash Register: 4, 9, 16</li> <li>Quick Select/Inspire Me: 6, 12, 20</li> </ul>	<ul style="list-style-type: none"> <li>Number of products displayed simultaneously</li> <li>Default: 16 or 12</li> </ul>
Adapt drinks	Yes/No	<ul style="list-style-type: none"> <li>Possibility for self-service customers to modify the selected drink in accordance with the allocation of the selection buttons</li> <li>Default: No</li> </ul>
Custom images	Yes/No	<ul style="list-style-type: none"> <li>Permit customer-specific images</li> <li>Default: No</li> </ul>
Options: Display the cancel button	Yes/No	

1.4 Cleaning

Parameters	Value range	Remarks
Process behavior: Buzzer	Yes/No	<ul style="list-style-type: none"> <li>Acoustic prompts for actions during cleaning</li> <li>Default: No</li> </ul>

# 1 Set Machine (continued)

## 1.7 Temperatures

<i>Parameters</i>	<i>Value range</i>	<i>Remarks</i>
Coffee	-20 % - +20 %	<ul style="list-style-type: none"> <li>The temperature in the coffee boiler is preset by the service technician</li> <li>The set temperature can be adjusted by percentages using the sliding controller</li> </ul>
Hot water/steam	-20 % - +20 %	<ul style="list-style-type: none"> <li>The temperature in the hot water/steam boiler is preset by the service technician</li> <li>The set temperature can be adjusted by percentages using the sliding controller</li> </ul>
Tea water	-20 % - +20 %	<ul style="list-style-type: none"> <li>The temperature in the hot water boiler is preset by the service technician</li> <li>The set temperature can be adjusted by percentages using the sliding controller</li> </ul>

## 1.11 Flavor

<i>Parameters</i>	<i>Value range</i>	<i>Remarks</i>
Flavor: Counting active	Yes/No	Switching the counting of the Flavor products On/Off
Flavor 1 - 3	<ul style="list-style-type: none"> <li>[list of the syrup varieties]</li> <li>User-defined</li> </ul>	<ul style="list-style-type: none"> <li>Only the Flavor types stored here will be available later for the drinks settings</li> <li>If <b>User-defined</b> is selected, the Flavor types can be named according to preference</li> </ul>

## 1.12 Accounting

<i>Parameters</i>	<i>Value range</i>	<i>Remarks</i>
Select payment type	On/Off	Switch Payment On/Off
Pay popup: Show popup	Yes/No	Activate/deactivate the display of the popup window

## 1.14 Edge lighting

<i>Parameters</i>	<i>Value range</i>	<i>Remarks</i>
Select lighting	<ul style="list-style-type: none"> <li>Off</li> <li>Red, green, blue</li> </ul>	Default: Color gradient
Error display on edge lighting	Yes/No	

## Setting drinks

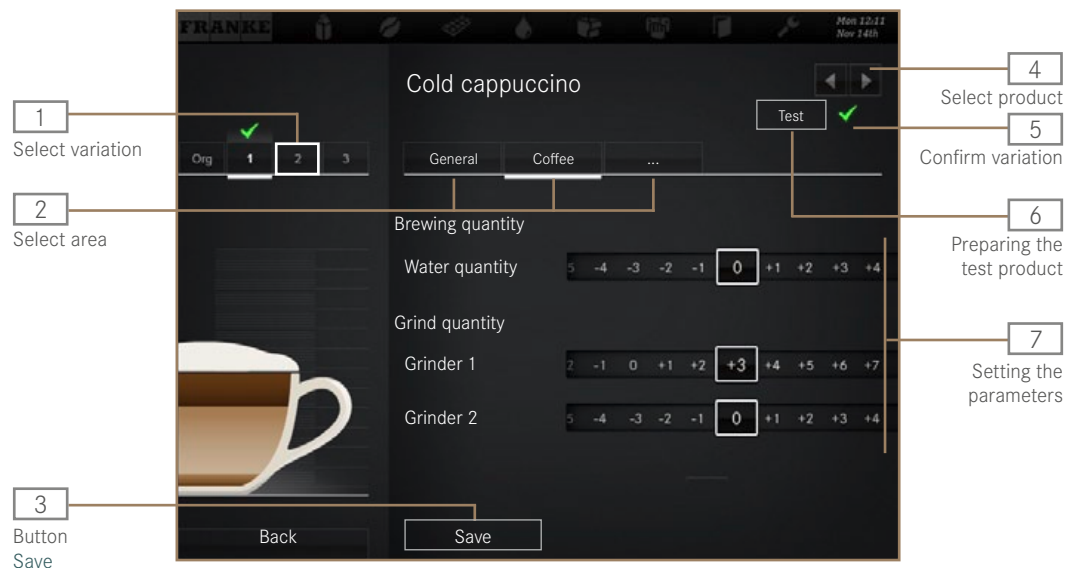

- You can save each product in three user-specific variations. The original cannot be changed.
- Only parameters that are relevant for the product are displayed.
- The percentage specifications are always based on the preset value.
- Tips for configuring the parameters can be found in the "Help with problems concerning product quality" chapter, p. 56.

Task	Menu item	Information / Instruction	Number
Selecting a product		Use the selection arrows to select the product to be defined, then select the variation to be edited	4, 1
Changing the product designation and product text	<b>General</b>	Enter the product designation and select the product text	2, 7
Determining the price (only available when payment is activated)	<b>General</b>	Determining PLU, prices and tokens; select the <b>Free</b> option	7
Adjusting the water quantity, grinders, pre-brewing and pressure amounts	<b>Coffee</b>	Adapting the parameters	2, 7
Adjusting the milk quantity	<b>Milk</b>	Adjusting the milk quantity by percentages	2, 7
Adjusting the foam quantity	<b>Milk foam</b>	Adjusting the foam quantity by percentages	2, 7
Changing the powder options	<b>Powder</b>	Adjusting the water quantity of 1 and 2, powder quantity of 1 and 2 by percentages	2, 7
Adding/deleting syrups	<b>Flavor</b>	Adjusting the syrup quantity of the various flavors by percentages	2, 7
Preparing the test product	<b>Test</b>	Use <b>Test</b> to prepare the selected product using the modified settings	6
Assigning drink variation that is to be prepared with this product selection		Select the variation, then confirm with the checkmark	1, 5
Saving drink settings	<b>Save</b>	Use <b>Save</b> to save the drink configuration	3

# Date and Time

Date and Time

On/Off Machine

<i>Parameters</i>	<i>Value range</i>	<i>Remarks</i>
With PIN	Yes/No	<ul style="list-style-type: none"> <li>• Yes: The coffee machine can be switched on or off only with the PIN code</li> <li>• Default: No</li> </ul>

Date and time

<i>Parameters</i>	<i>Value range</i>	<i>Remarks</i>
Display	12 h/24 h	-
Day	0 - 31	Set the day
Month	0 - 12	Set the month
Year	0 - 63	Set the year
Hour	0 - 23/0 - 11	Configure hours
Minutes	0 - 59	Configure minutes

Timer 1 - 4

<i>Parameters</i>	<i>Value range</i>	<i>Remarks</i>
Active	Mo, Tu, We, Th, Fr, Sa, Su	Activate or deactivate days by tapping
On/Off hours	0 - 23/0-11	Switch-on time (hour)
On/Off minutes	0 - 59	Switch-on time (minute)
Monday - Sunday	Yes/No	Day on which the machine will switch on automatically

## 6 Access rights

6 Access rights			
6.2 Owner	<i>Parameters</i>	<i>Value range</i>	<i>Remarks</i>
	Set PIN	0 - 9	<ul style="list-style-type: none"> <li>• Authorizations: Access to My Settings; call up counter values</li> <li>• Default PIN: 1111</li> </ul>
6.3 Specialist	<i>Parameters</i>	<i>Value range</i>	<i>Remarks</i>
	Set PIN	0 - 9	<ul style="list-style-type: none"> <li>• Authorizations: Limited access to My Settings; call up the counter values of all products</li> <li>• Default PIN: 2222</li> </ul>
6.4 Operator	<i>Parameters</i>	<i>Value range</i>	<i>Remarks</i>
	Set PIN	0 - 9	<ul style="list-style-type: none"> <li>• Authorization: Call up the counter value of all products</li> <li>• Default PIN: 7777</li> </ul>
6.6 Key (secured) products	<i>Parameters</i>	<i>Value range</i>	<i>Remarks</i>
	Set PIN	0 - 9	Authorization: Lock and unlock key (secured) products Default PIN: 8888
6.7 On/Off Machine	<i>Parameters</i>	<i>Value range</i>	<i>Remarks</i>
	Set PIN	0 - 9	Authorization: Switch the coffee machine On/Off Default PIN: 9999

# Counters

	Owner menu items	Specialist menu items	Operator menu items
Without VIP system (Standard)	4.1 Machine total	-	-
	4.2 Cycles		
	4.3 Water filter	-	-
	4.4 Grinders/dosing units		
	4.5 Cleanings	-	-
	4.6 Coffee products	-	-
	4.7 Milk products	-	-
	4.9 Water products	-	-
	4.10 Powder products	-	-
	4.11 Flavor products	-	-
	4.12 All products	4.12 All products	4.12 All products
	4.13 Maintenance	-	-
	With VIP system	4.3 Water filter	-
4.5 Cleanings		-	-
4.13 Maintenance		-	-
4.15 Product counters		4.15 Product counters	4.15 Product counters
4.16 Total product counters		4.16 Total product counters	4.16 Total product counters
4.17 List counters		4.17 List counters	4.17 List counters
4.18 List counters total		4.18 List counters total	4.18 List counters total
4.19 Sales		4.19 Sales	4.19 Sales
4.20 Exporting		4.20 Exporting	4.20 Exporting
4.21 Resetting		4.21 Resetting	4.21 Resetting

# INDIVIDUALIZATION AND DATA TRANSFER

Your A600 opens up versatile possibilities for individualization.  
Use the advantages of the touch screen for your sales ideas.

## Overview



- All of the menu items of the Individualization and data transfer menu are depicted on the following pages.
- The PIN code for the Individualization and data transfer menu is identical with the PIN code for the Settings menu. The factory-set PIN code is 0000. We recommend that you note the PIN code for the Individualization and data transfer menu here:

## Functions

You can load and view your own image objects in the Individualization and data transfer menu. In addition, you can save your settings.

Use either the Franke images that are available or your own images for drinks, screen savers or as advertising images. Configure the behavior of the various operating modes or of the screen savers.

Create backups of your A600 on a regular basis. Simply insert a USB stick and start the process. Fast, simple and secure.



01 Switch to Maintenance level.

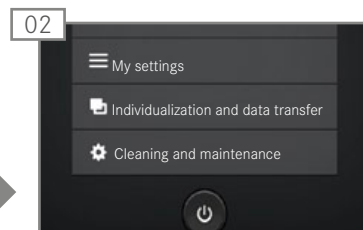

02 Select Individualization and data transfer.



Confirm each of the changes with Save.



# Individualization and data transfer

	Owner menu items	Specialist menu items	Operator menu items
1 Manage images	1.1 Load images 1.2 Backing up images 1.3 Advertising images 1.4 Product images 1.5 Screen saver 1.6 Eject USB stick 1.7 Create directory structure	1.1 Load images 1.2 Backing up images 1.3 Advertising images 1.4 Product images 1.5 Screen saver 1.6 Eject USB stick 1.7 Create directory structure	-
2 Modify depiction	2.1 Activate drinks 2.2 Image carousel 1.4 Screen saver 2.4 My screen saver 2.5 Video Screen Saver 2.6 Menu cards 2.7 Advertising images 2.8 My advertising images 2.9 Sort quick select 2.10 Sort cash register 2.11 My Product Images	- - - 2.4 My screen saver 2.5 My Video Screen Saver - - 2.7 My Advertising Images - - -	-
3 Backing up/loading data	3.1 Backing up data 3.2 Backing up XML data	3.1 Backing up data 3.2 Backing up XML data	- 3.2 Backing up XML data
4 Set default values	4 Set default values	4 Set default values	
5 Import FPC	5 Import FPC	5 Import FPC	-
6 Import PKT	6 Import PKT	6 Import PKT	
7 Eject USB stick	7 Eject USB stick	7 Eject USB stick	7 Eject USB stick

# Individualization and data transfer menu tree

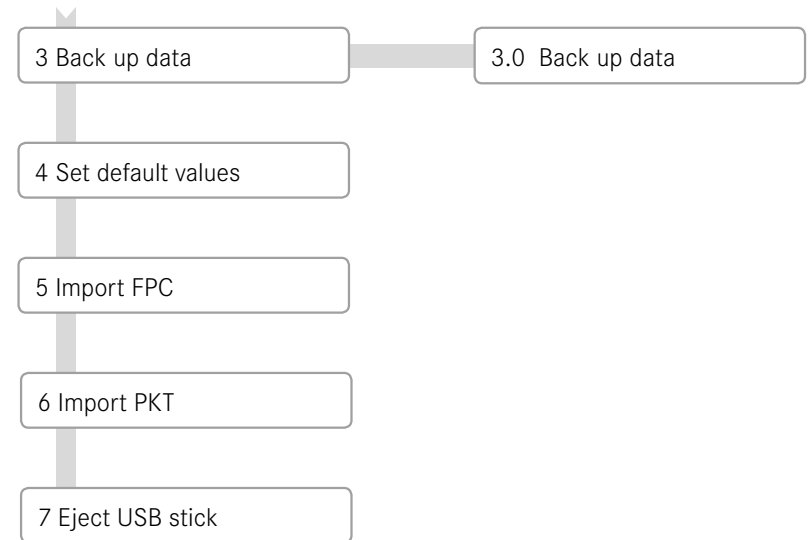
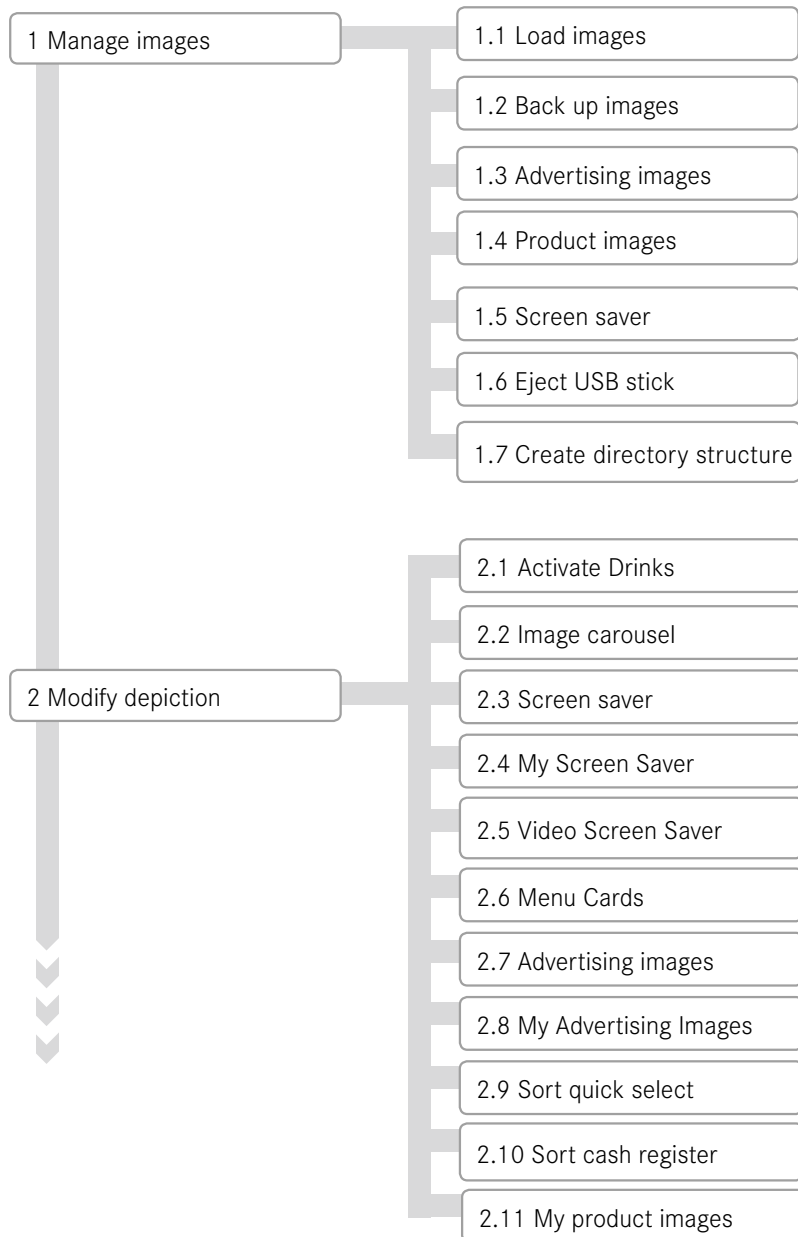

- With 4 set default values, selected parameters can be reset to the preset values.
- 5 Import FPC becomes usable when a USB stick with a valid Franke product catalog is connected.
- 7 Eject USB stick logs off connected USB sticks. If a USB stick is being used, the menu item will appear in green, otherwise it appears in orange.

## Requirements of my image material

			
	Advertising images	Screen saver	Drink images
Image size (width x height)	800 x 600 px	800 x 600 px	430 x 274 px
Data format	PNG with 24-bit	PNG with 24-bit	PNG with 24-bit and 8-bit alpha channel if necessary
Orientation	—	—	Centered on vertical axis
Memory folder on USB stick	Drive:\QML-Files\rc\custom\images	Drive:\QML-Files\rc\custom\screensavers	Drive:\QML-Files\rc\custom\drinks

## Necessary folder structure on the USB stick



You must maintain a specific directory structure so that the A600 can recognize your images without difficulty. Create the folder structure one time, save it and it will be quickly available. You can also generate this directory structure automatically. For this, use the menu item "1.7 Generate directory structure".

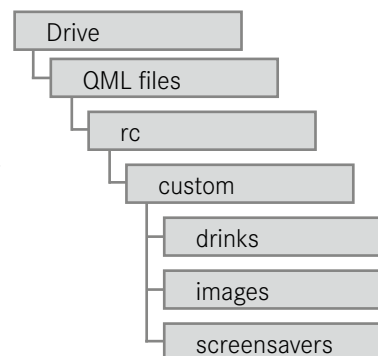

# Loading or clearing my images

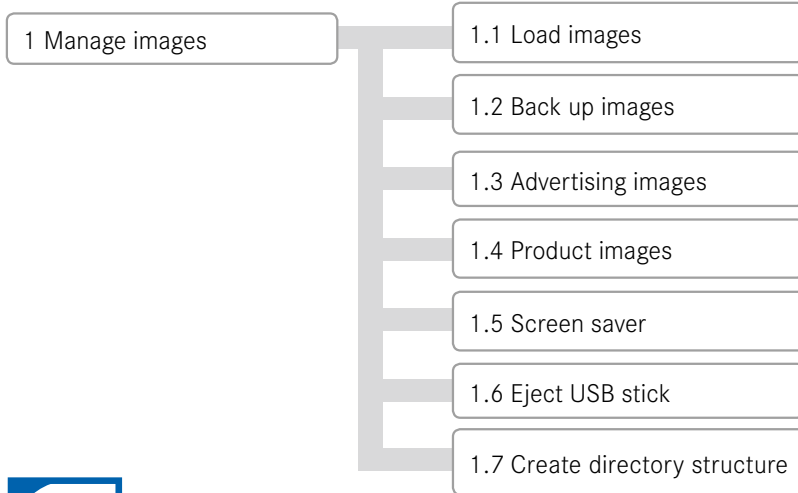

- The upload process is the same for all images.
- The images on the USB stick must be present in the required folder structure, have the correct data format and the correct size, see p. 48.

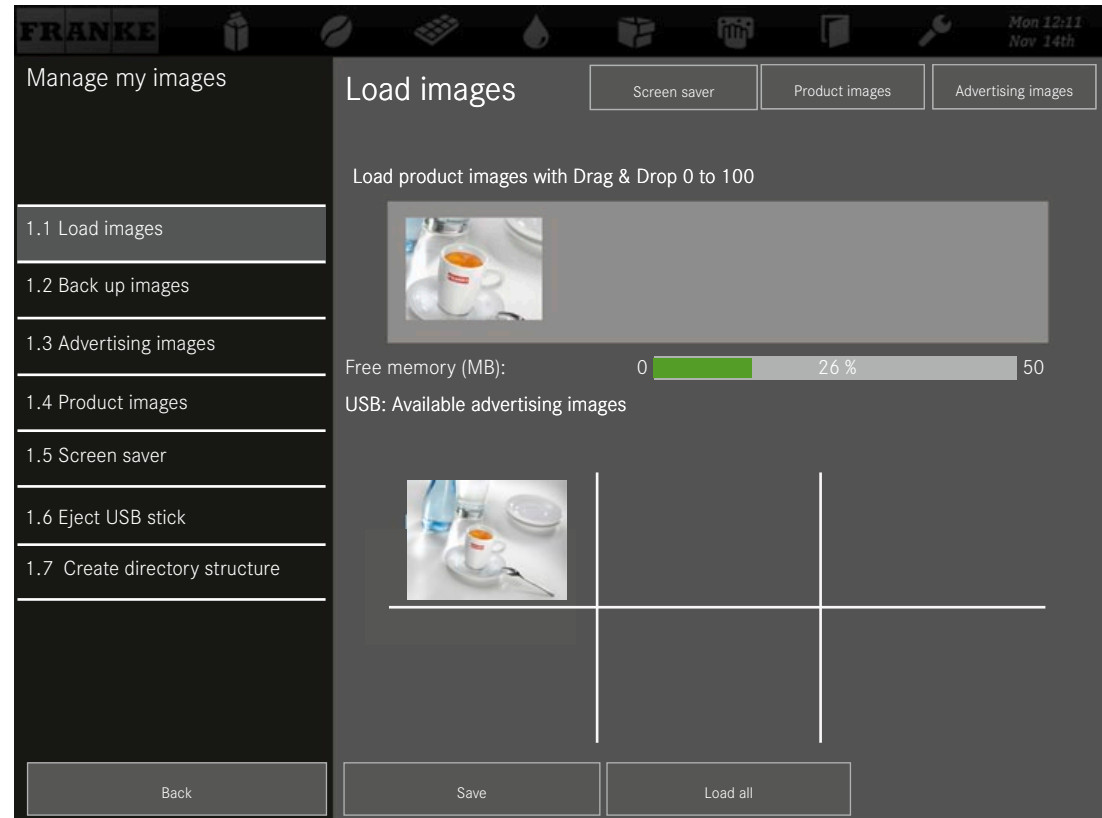

Desired action	Menu item	Information / Instruction
Loading images to the machine	<b>1.1 Load images</b>	<ul style="list-style-type: none"> <li>• Insert a USB stick with the required directory structure.</li> <li>• Select the image type.</li> <li>• Select the images that you wish to load onto the machine using Drag&amp;Drop and press <b>Save</b>.</li> </ul>
Saving images from the machine	<b>1.2 Back up images</b>	<ul style="list-style-type: none"> <li>• Insert a USB stick.</li> <li>• Select the image type.</li> <li>• Save individual images or all images to the USB stick.</li> </ul>
Clearing images	<b>1.3 Advertising images</b> <b>1.4 Product images</b> <b>1.5 Screen saver</b>	<ul style="list-style-type: none"> <li>• Open the desired menu.</li> <li>• Select the images that are no longer needed and delete them by tapping the <b>Clear</b> button.</li> </ul>

# Using my images

## Configuring my screen saver

- 2 Modify depiction
  - 2.1 Activate drinks
  - 2.2 Image carousel
  - 2.3 Screen saver
  - 2.4 My screen saver
  - 2.5 Video screen saver
  - 2.6 Menu cards
  - 2.7 Advertising images
  - 2.8 My advertising images
  - 2.9 Sort quick select
  - 2.10 Sort cash register
  - 2.11 My Product Images

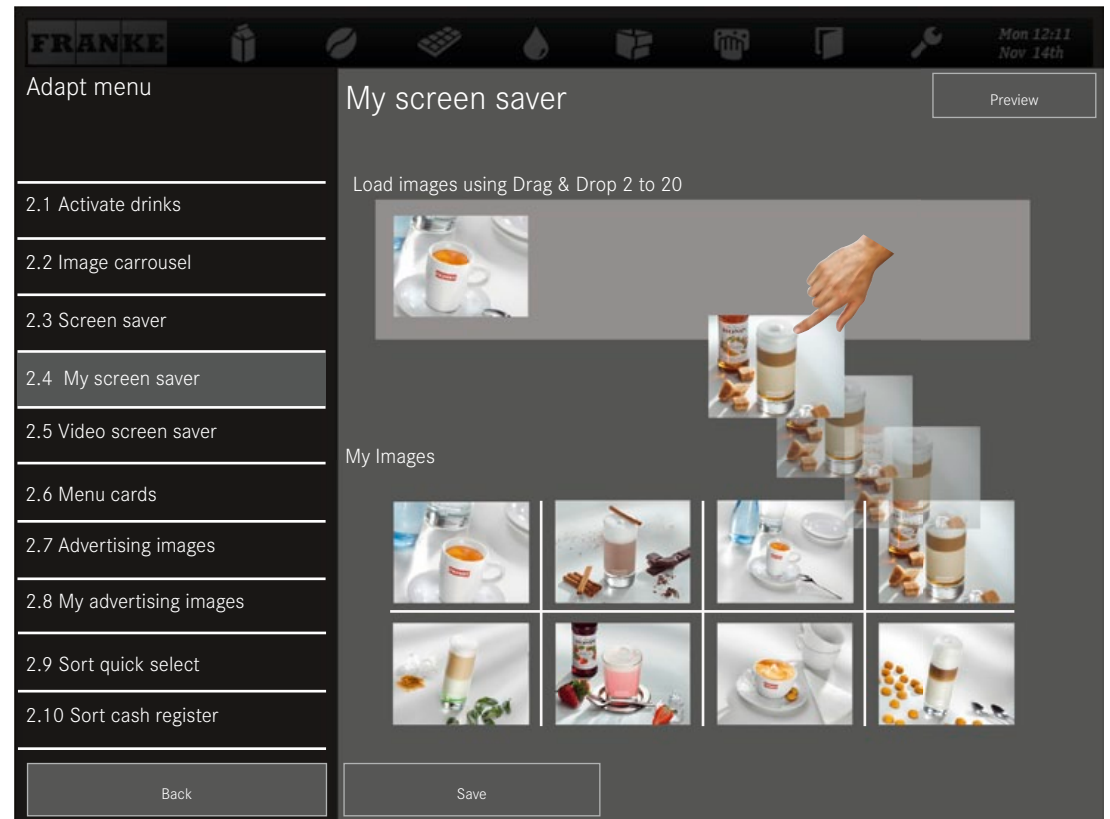

Make sure that the image carousel and the screen saver are deactivated.

Desired action	Menu item	Information / Instruction
Using images	2.1 - 2.6	Tap the image that you wish to use in the lower area and drag it to the top.
Removing used images	2.1 - 2.6	Tap an image that you no longer wish to use in the upper area and drag it to the bottom.
Viewing selection	2.1 - 2.6	Select <b>Preview</b> to check your selection.

## Configuring my advertising images

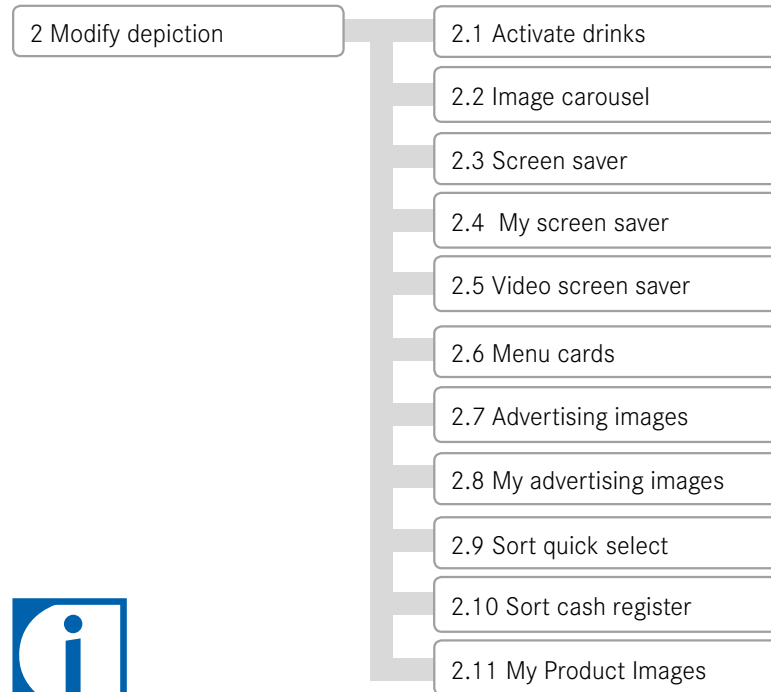

The activated advertising images can be switched on for each drink in the menu item under My Settings > Set Drinks.

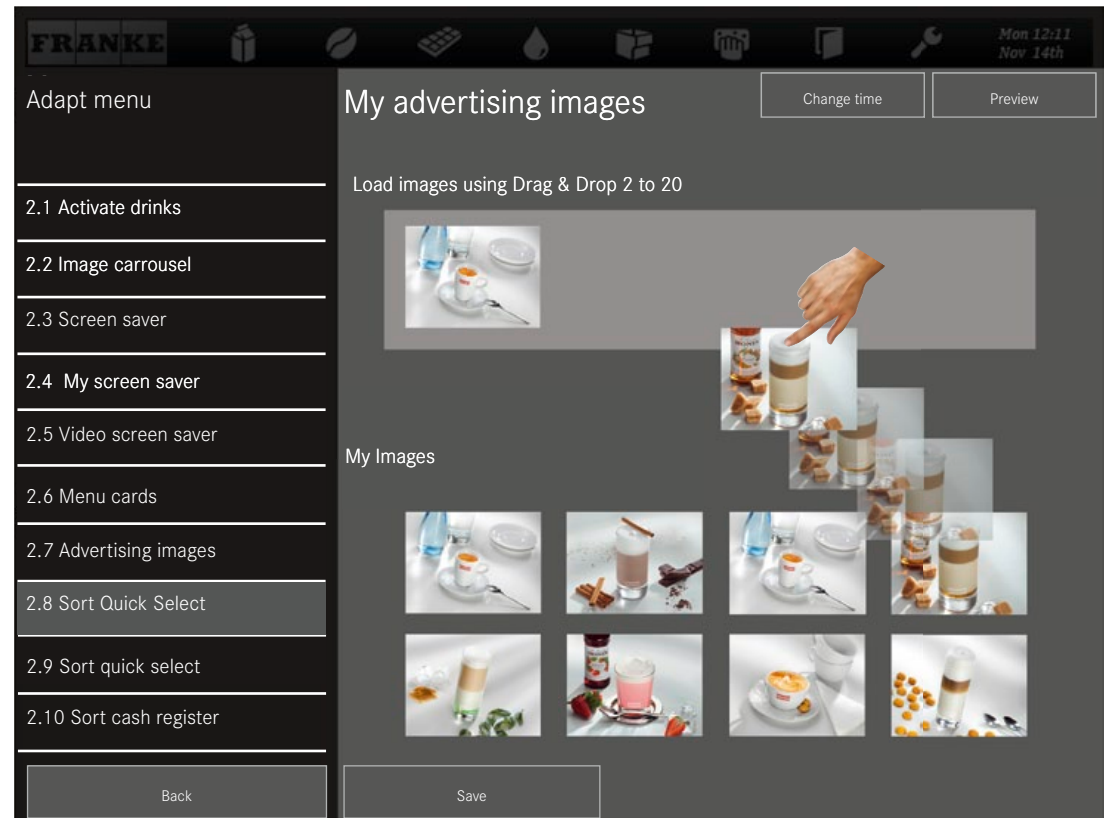

## Assigning my product images

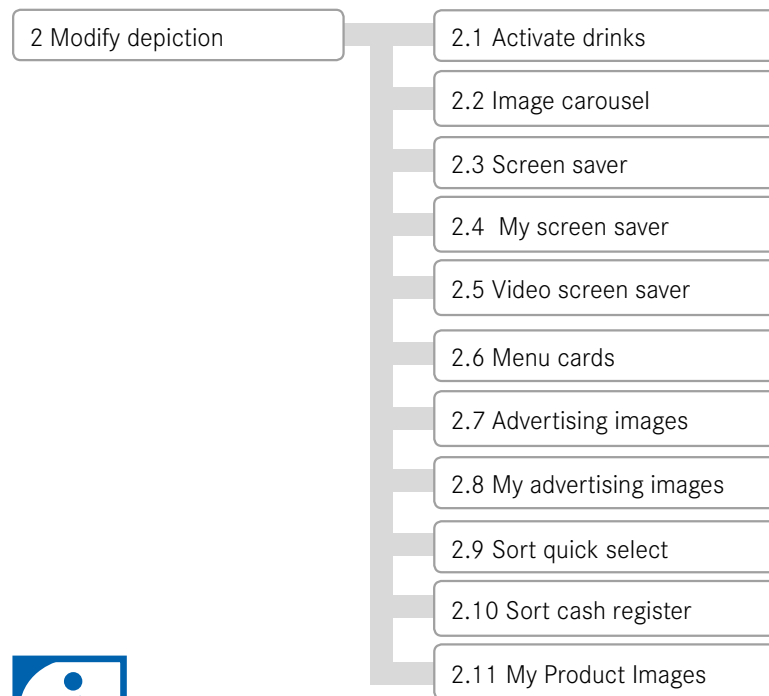

- An image must be assigned to each available product.
- The images can be activated through the menu item **My Settings > Set Machine > Operation Mode**.
- Products to which no image has been assigned will be displayed without an image.
- You can either use the Franke images or your own, but you cannot mix the two types with one another.

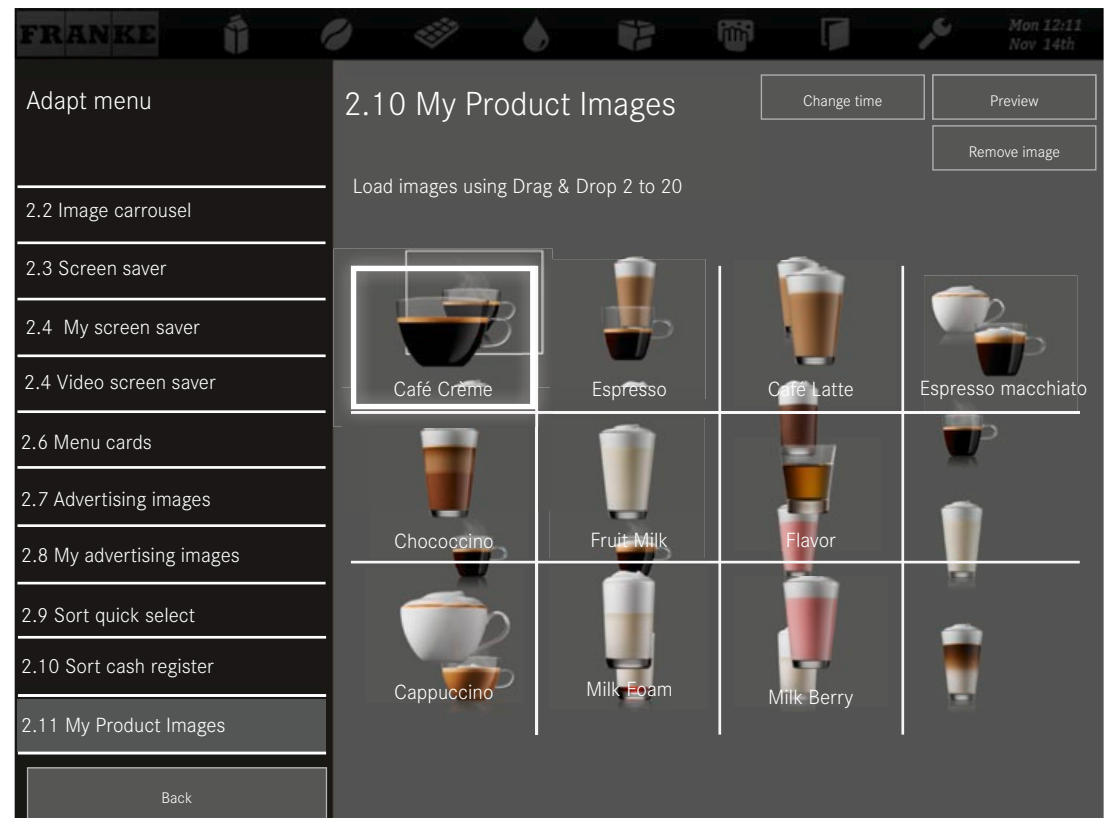

# DECOMMISSIONING AND DISPOSAL

Do you want to shut down your coffee machine for longer periods or dispose of it?  
Benefit from our service.

## Decommissioning

For all your decommissioning needs

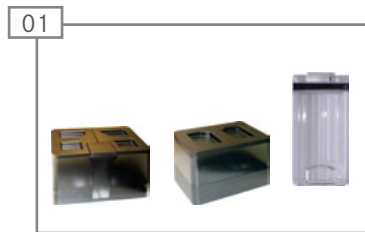

01 Empty the bean hopper and powder container.  
Empty the milk container.



02 Carry out automatic cleaning of the coffee machine. You will find help for this in the chapter "Care of the A600".



03 Clean the coffee bean hopper and powder container.  
Clean the milk container and the milk tube.



For short-term decommissioning of up to 3 weeks – continue with Step 04.  
For a longer or a permanent decommissioning – see notes on the next page.

## Short-term decommissioning (up to 3 weeks)

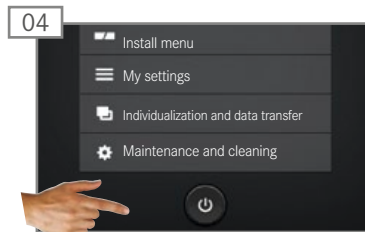

04 Call up energy saver mode and disconnect the machine from the power supply.



05 Switch off the add-on units and disconnect them from the power supply.



06 Turn off the water supply and empty the water tank if there is one.



# Long-term decommissioning and storage

## NOTE

### Ensure functional capability.

Contact the FRANKE Service team for proper decommissioning and storage.

Have your coffee machine drained by your service technician and observe the storage conditions:

- Storage temperatures: -10 °C to 50 °C
- Humidity: max. 80%

If you plan to start using your machine again later, taking advantage of our service is essential.

The coffee machine must be maintained, installed and cleaned prior to drink preparation.

Proper coffee machine functioning cannot otherwise be ensured.

## Disposal

### Disposing of consumable materials

- Beans, powder and coffee grounds can be composted.
- The information enclosed with the detergent applies for the disposal of unused cleaning tablets, clean solution and descaler.

### Disposal of the coffee machine and the FoamMaster



The A600/A600 FM coffee machine is in compliance with the European Directive 2012/19/EU regarding waste electrical and electronic equipment (WEEE) and may not be disposed of with domestic refuse.

The tetrafluorethane (R134a) coolant used for the FoamMaster requires no special means of disposal.

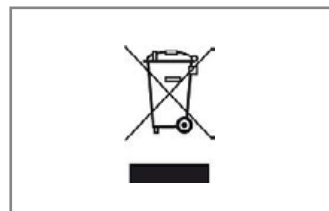

Dispose of electronic parts separately.



Dispose of plastic parts in accordance with their labels.



Two people are required for transporting the coffee machine.

# TROUBLESHOOTING

Help is available from your A600 in the event of problems. Events and information are displayed on the monitor screen. If you are still unable to resolve the problem despite your best efforts, please contact our Service department.

## Elimination of machine errors

### Non-self-service mode

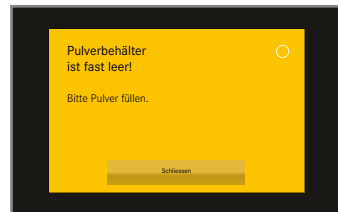

An error is displayed using a symbol highlighted with a color in non-self-service mode.

A message with instructions.



Contact your service technician if the machine cannot be started or if you are unable to rectify the error.



The machine must be restarted in the event of serious errors. Check the power supply if the machine fails to start.

If the entire system is affected by an error, error messages will appear automatically.

### Self-service mode

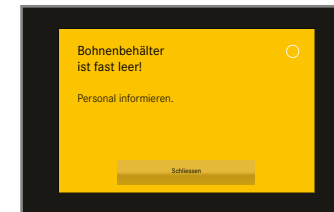

An error is displayed using a colored corner in self-service mode.

A message with instructions for your customer.

### Color code for error messages



Temporary interruption



System still fully functional.



System has limited functionality.



Some or all resources are locked.

## Help with problems concerning product quality

	Possible causes	Possible solutions
Coffee tastes stale	Grind too coarse	Select a finer grind ( <i>see p. 22</i> )
	Too little coffee	Increase amount of coffee
	Temperature too low	Increase temperature
	Coffee is too old	Use fresh coffee
	Bean hopper not locked correctly	Check bean hopper locking mechanism ( <i>see p. 22</i> )
Coffee tastes strange	Poor grind	Contact customer service
	Minimal coffee usage	Pour a small amount of coffee beans into the bean hopper
	Spoiled coffee beans	Replace coffee beans
	Residual cleaning solution	Rinse the machine
	Dirty cup	Check dishwasher
	Water (chlorine, hardness etc.)	Have water quality checked
Coffee tastes bitter	Temperature too high	Lower coffee temperature
	Grind too fine	Select a coarser grind ( <i>see p. 22</i> )
	Coffee quantity too low	Increase amount of coffee
	Roast too dark	Use lighter coffee roast
Coffee tastes sour	Temperature too low	Increase coffee temperature
	Roast too light	Use darker coffee roast
	Grind too coarse	Select a finer grind ( <i>see p. 22</i> )
Consistency of powder products	Viscous	Use less powder, use more water
	Watery	Use more powder, use less water
	Powder clumping or moist	Clean and dry powder system
Taste of powder products	Too sweet	Use less powder, use more water
	Not sweet enough	Use more powder, use less water
	Strange taste	Clean powder system

# INDEX

5-STEP METHOD . . . . .	31
<b>A</b>	
ACCESSORIES	
CLEANING . . . . .	36
ACCESS RIGHTS . . . . .	43
ADD-ON UNITS. . . . .	13
CUP WARMER . . . . .	13
FLAVOR STATION . . . . .	13
REFRIGERATION UNIT . . . . .	13
ADJUSTABLE FEET . . . . .	18
ADVERTISING IMAGES . . . . .	47, 51
AUTOMATIC CLEANING . . . . .	31
AUTOSTEAM . . . . .	30
<b>B</b>	
BACKING UP DATA . . . . .	47
BEAN HOPPER . . . . .	10, 11
BREWING UNIT . . . . .	11
<b>C</b>	
CAPACITIES . . . . .	10
CARE . . . . .	31
CASH REGISTER . . . . .	15
SORTING . . . . .	47
CLEANING . . . . .	31
BEAN HOPPER . . . . .	35
BREWING UNIT . . . . .	36
CONTAINER . . . . .	12
MONITOR SCREEN . . . . .	34
STEAM WAND . . . . .	33
WATER TANK . . . . .	36
COLOR CODE . . . . .	7
COMPONENTS	
A600 . . . . .	11
CONFIGURATION . . . . .	38
MENU TREE . . . . .	38
CONTROL UNIT . . . . .	10
COUNTERS . . . . .	44
CREATE DIRECTORY STRUCTURE . . . . .	47
CREDIT MODE . . . . .	16
<b>D</b>	
DAILY COMMISSIONING . . . . .	20
DATA TRANSFER . . . . .	46
DATE AND TIME . . . . .	42
DECOMMISSIONING . . . . .	53
LONG-TERM . . . . .	54
SHORT-TERM . . . . .	53
DESCRIPTION OF MACHINE . . . . .	10
FLAVOR STATION . . . . .	13
REFRIGERATION UNIT . . . . .	13
CUP WARMER . . . . .	13
DIMENSIONS . . . . .	18
DISPOSAL . . . . .	53, 54
COFFEE MACHINE . . . . .	54
CONSUMABLE MATERIALS . . . . .	54
DRINKS	
ACTIVATING . . . . .	47
PREPARING . . . . .	26
DRIP GRID . . . . .	10
DRIP TRAY . . . . .	10, 11
<b>E</b>	
EMPTY	
BEAN HOPPER . . . . .	22
GROUNDS CONTAINER . . . . .	23
POWDER CONTAINER . . . . .	23
REFRIGERATION UNIT . . . . .	25
ENERGY SAVER MODE . . . . .	14
ERROR MESSAGES . . . . .	7
DEPICTION . . . . .	7
EXPENDABLE MATERIALS . . . . .	60
<b>F</b>	
FILLING . . . . .	21
BEANS . . . . .	21
POWDER . . . . .	21
WATER . . . . .	21
WATER TANK . . . . .	22

FOAMMASTER . . . . .	12
CONFIGURE . . . . .	37
FOLDER STRUCTURE . . . . .	48
FOOD RESIDUE. . . . .	4
FRONT DOOR. . . . .	10
<b>G</b>	
GROUND COFFEE . . . . .	29
GROUNDS CONTAINER . . . . .	11
<b>H</b>	
HEIGHT ADJUSTMENT . . . . .	10
HOT WATER DISPENSER . . . . .	10
<b>I</b>	
IDENTIFICATION . . . . .	8
IMAGE CAROUSEL . . . . .	47
IMAGES	
BACK UP . . . . .	47
LOADING . . . . .	47
REQUIREMENTS . . . . .	48
IMPORTING FPC . . . . .	47
IMPORTING PKT. . . . .	47
INDIVIDUALIZATION AND DATA TRANSFER . . . . .	45
INDIVIDUALIZATION	
DATE AND TIME. . . . .	42
LANGUAGE . . . . .	39
INITIAL COMMISSIONING . . . . .	20
INSPIRE ME . . . . .	15
INSTALLATION . . . . .	17
PREPARATIONS . . . . .	17
INSTALLATION DIMENSIONS . . . . .	18

<b>L</b>	
LANGUAGE . . . . .	39
<b>M</b>	
MACHINE ERROR . . . . .	55
MAIN SWITCH . . . . .	12
MAINTENANCE	
MAINTENANCE PLAN . . . . .	32
COUNTERS. . . . .	44
MENU CARDS . . . . .	47
MENU ELEMENTS . . . . .	14
MENU TREE. . . . .	38
"SETTINGS" . . . . .	38
MILK CONTAINER . . . . .	12
FILLING . . . . .	24
MY ADVERTISING IMAGES . . . . .	47
MY IMAGES. . . . .	49
MY PRODUCT IMAGES . . . . .	47
MY SCREEN SAVER . . . . .	47
MY SETTINGS . . . . .	38
<b>N</b>	
NAVIGATION . . . . .	6, 14
<b>O</b>	
OPERATING INTERFACE. . . . .	14
OPERATING MODE. . . . .	39
OPERATING MODES . . . . .	15
ORDER NUMBER. . . . .	8, 60
ORIGINAL PARTS. . . . .	60
OUTLET . . . . .	10
HEIGHT ADJUSTMENT. . . . .	10

<b>P</b>	
PAYMENT SYSTEM. . . . .	13
PIN	
DEFAULT PIN . . . . .	37
POWDER CONTAINER. . . . .	10, 11
CLEANING . . . . .	35
POWDER LID . . . . .	10, 29
POWER CONNECTION CABLE . . . . .	60
PREPARING DRINKS	
CASH REGISTER . . . . .	27
INSPIRE ME . . . . .	28
QUICK SELECT . . . . .	26
PREPARING THE MILK SYSTEM . . . . .	24
PRODUCT IMAGES. . . . .	47, 52
PRODUCT QUALITY . . . . .	56
PROGRAMMING . . . . .	37
PROPER USE . . . . .	2
<b>Q</b>	
QUICK SELECT. . . . .	15
PREPARING DRINKS. . . . .	26
<b>R</b>	
RINSING. . . . .	34
RISKS . . . . .	3
<b>S</b>	
SAFETY . . . . .	2
SCOPE OF DELIVERY . . . . .	8
SCREEN SAVER . . . . .	47
SETTING DEFAULT VALUES. . . . .	47
SETTING THE GRIND COARSENESS. . . . .	22
SETTING THE MACHINE. . . . .	38

SOFTWARE . . . . . 6  
 SORT QUICK SECTION . . . . . 47  
 STARTING THE AUTOMATIC CLEANING. . . . . 33  
 STEAM DISPENSER . . . . . 30  
 STEAM WAND . . . . . 10  
 STORAGE . . . . . 54  
 SYMBOLS . . . . . 5  
   OPERATING INSTRUCTIONS . . . . . 5  
   DASHBOARD . . . . . 6  
   5-STEP METHOD . . . . . 5

**T**

TECHNICAL DATA . . . . . 17  
   COFFEE MACHINE. . . . . 17  
   ADD-ON UNITS . . . . . 19  
 TEMPERATURES . . . . . 40  
 TIMER FUNCTION . . . . . 42  
 TRAINED PERSONNEL . . . . . 3  
 TROUBLESHOOTING . . . . . 55  
   MACHINE ERROR . . . . . 55  
   PRODUCT QUALITY . . . . . 55  
 TYPE KEY . . . . . 9  
 TYPE PLATE . . . . . 9

**U**

USB STICK . . . . . 48  
   EJECT . . . . . 47

**V**

VIDEO SCREEN SAVER . . . . . 46, 47

**W**

WASTEWATER TANK  
   EXTERNAL . . . . . 11

WATER TANK . . . . . 11, 12  
   EXTERNAL . . . . . 11  
   FILLING . . . . . 22  
   INTERNAL . . . . . 11  
 WIPE PROTECTION. . . . . 34

## Original parts

## Expendable materials

Item	Order number
Cleaning tablets (100 pcs.)	BK328400
Clean solution	1L301219
FoamMaster clean solution	1Z365033
Filter cartridge (6 pcs.)	1P315694

## Mains connection cable

Item			Order number
Mains connection cable	USA	30 A	1T310650
Mains connection cable	EU	10 A	1T310025
		16 A	1N330002
Mains connection cable	CH	10 A	1T310036
		16 A	1N330000
Mains connection cable	GB	10 A	1N330001
		16 A	1N330001
Mains connection cable	CN	10A	1T311643
		16A	1N330718
Mains connection cable	Yes	16A	1N330920



Franke Kaffeemaschinen AG  
Franke-Strasse 9  
4663 Aarburg  
Switzerland  
Tel. +41 62 78731 31  
www.franke.com



Your distribution partner:

Issued: 03.16/Order number: 1C345305/Revision B